

SANITIZER SLEEVE/WALLET



PORTABLE
WASHABLE / RE-USABLE

CUSTOMIZABLE DESIGNED SLEEVES

REFILL IT WITH HAND SANITIZER

SQUISH & WET HAND AND DRY WITH ANOTHER PART OF IT

A HANKERCHIEF THAT'S ON YOUR ARM OR IN YOUR POCKET

WRIST OR POCKET DESIGN

FITS OVER YOUR WATCH



RUBBING HANDS ON
OUTSIDE WETS WITH
SANITIZER & REMOVES
DIRT

OPEN UP WALLET &
SNEEZE INTO IT
WASHABLE WALLET FOR HAND
RUBBING TOWEL & HANKERCHIEF

HAND SANITIZER POUCH
SITS IN THE BOTTOM

HAS NORMAL WALLET
SPACE*

SPINABLE WALLET

PLACE YOUR OWN
HANKERCHIEF OR
TISUES

PURSE HOOK FOR
BAGS FOLDS OUT

ROLLER FOR SMOOTH
HAND WASHING

DESIGNED WET TOWEL
EXTERIOR FOR HAND
RUBBING

FITS LARGE HANDLE
BAGS & SITS ON
RIGHT ANGLES*

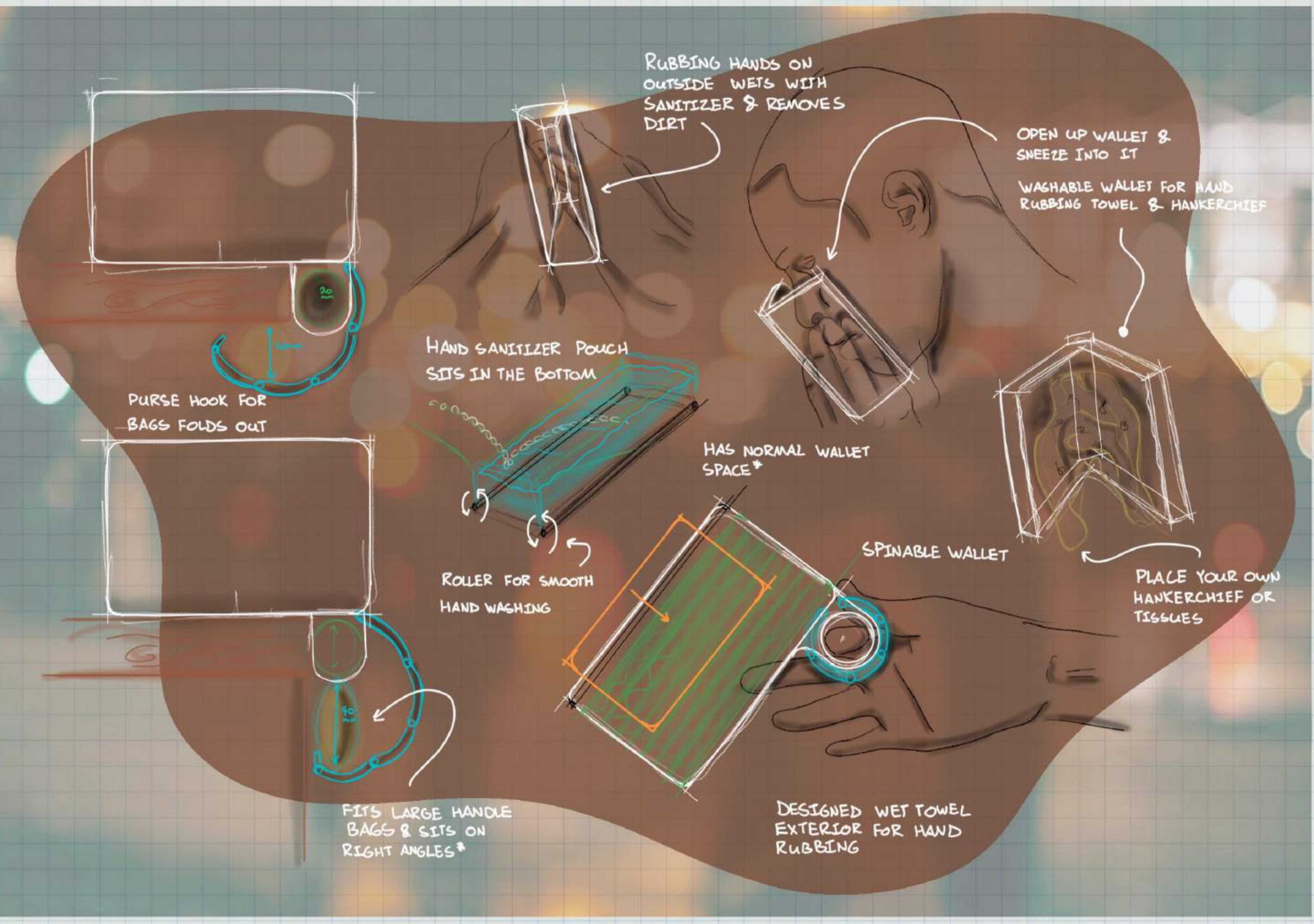

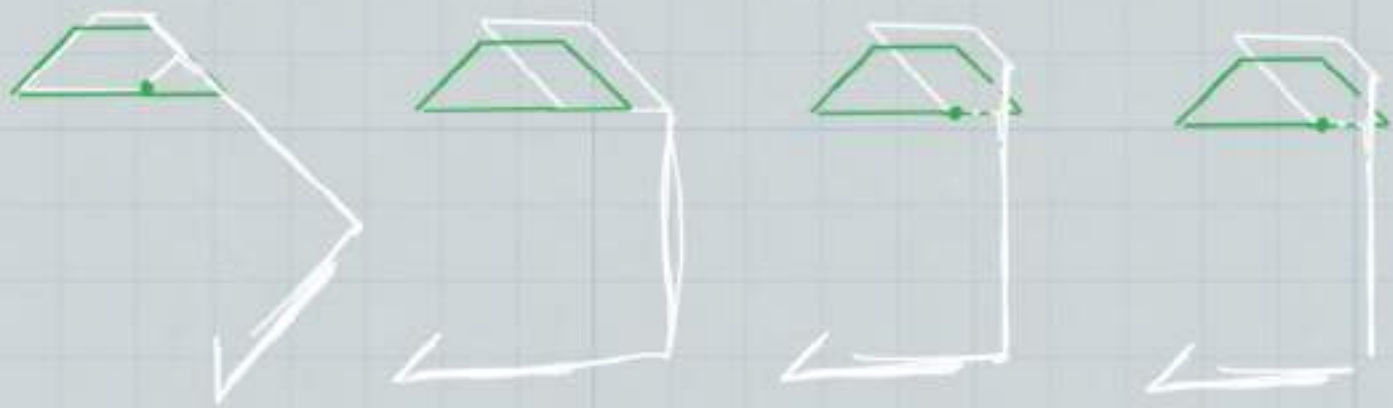
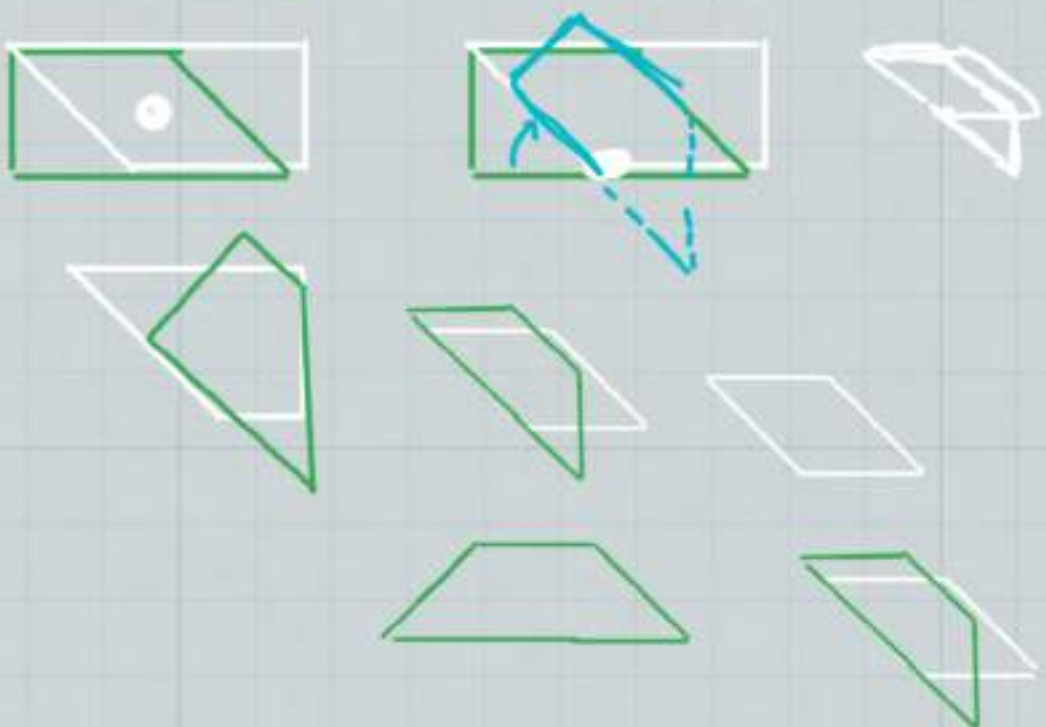
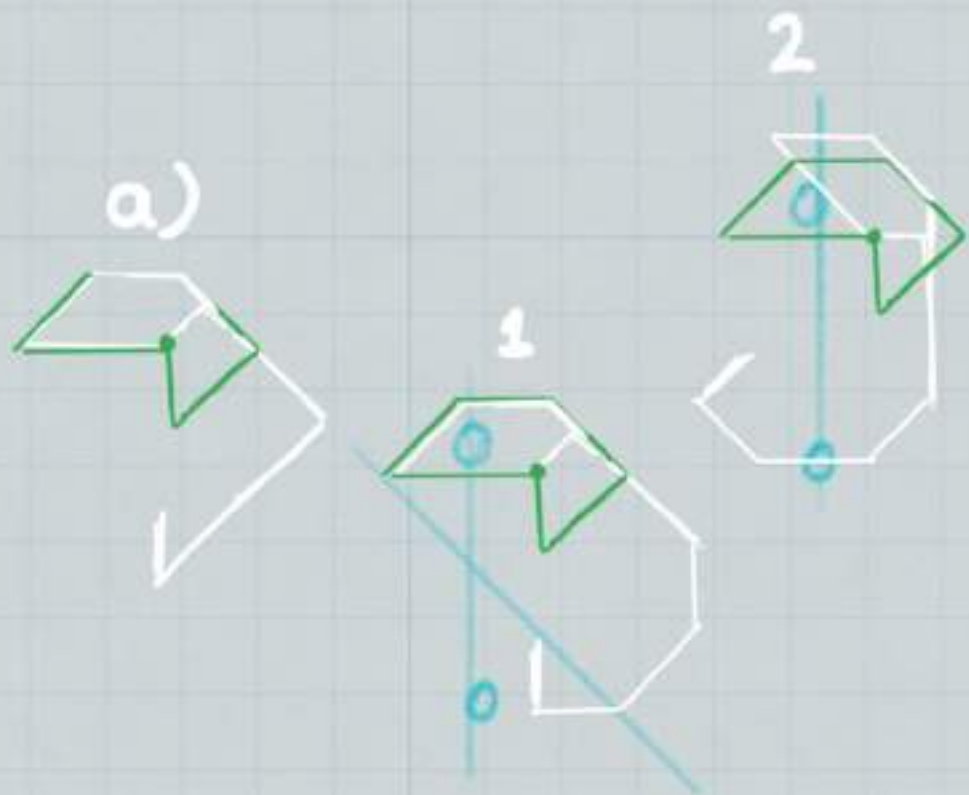
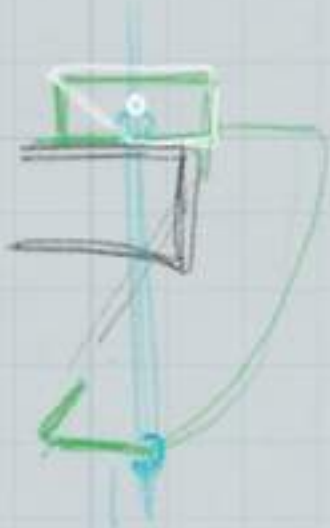
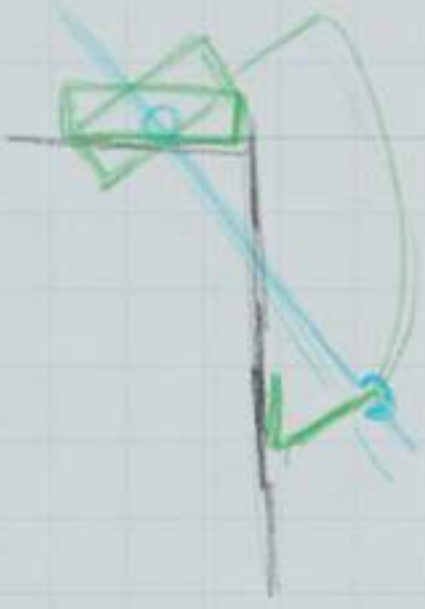
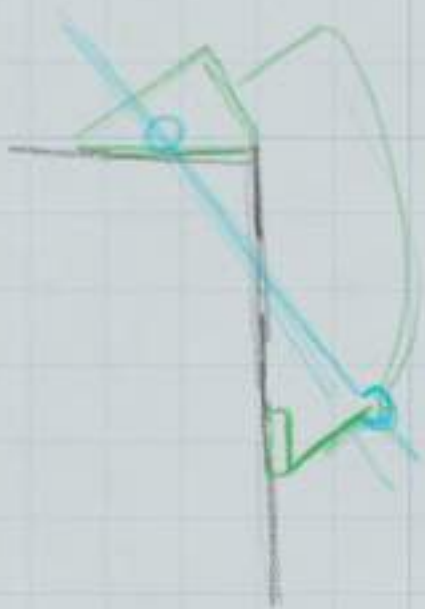
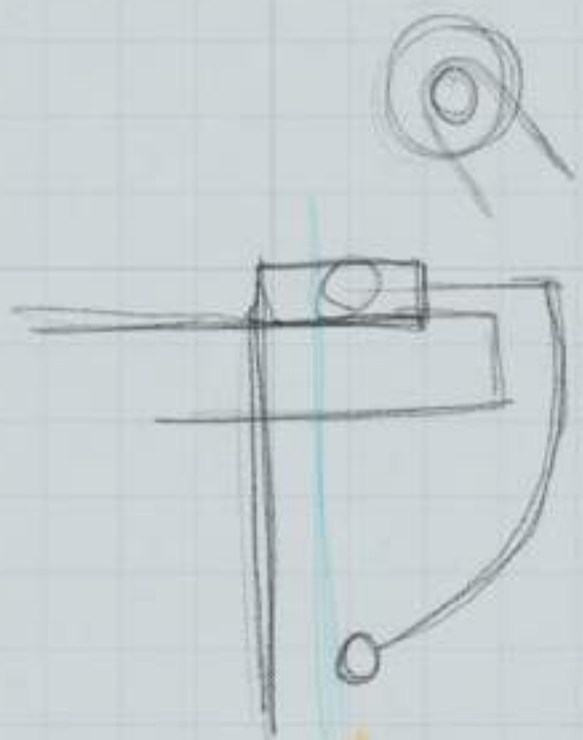

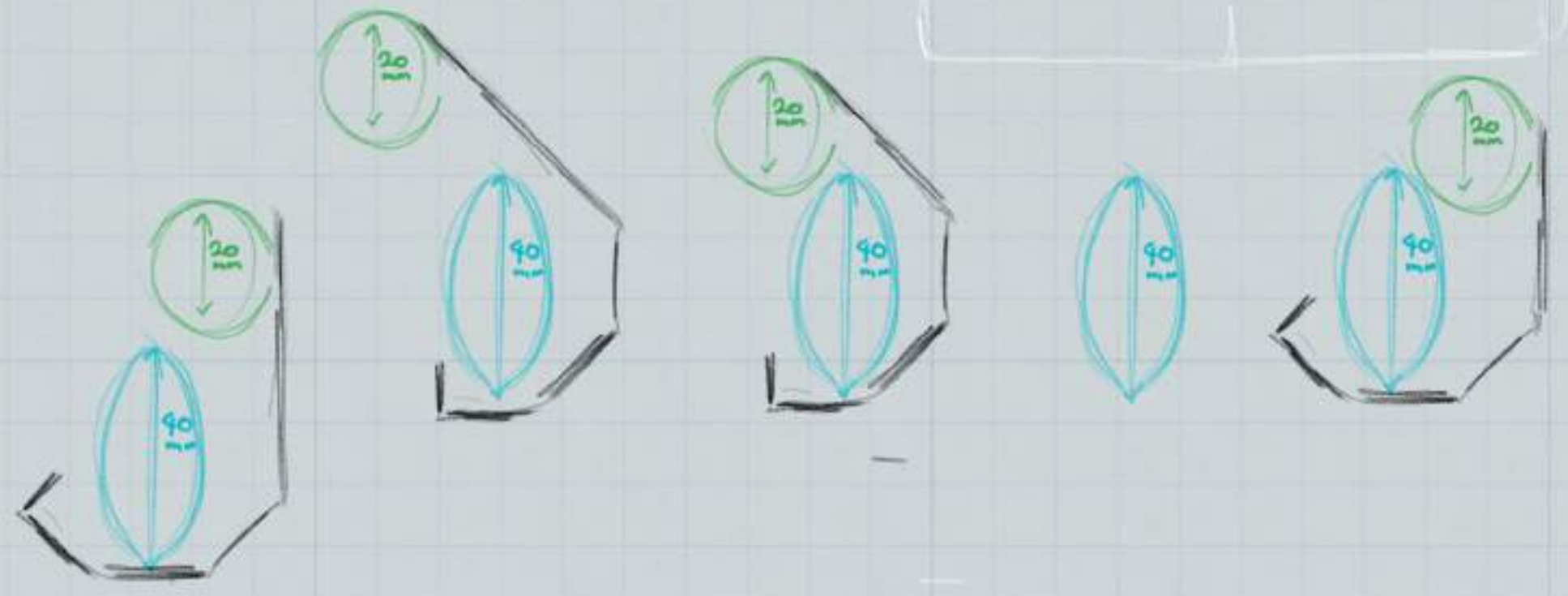
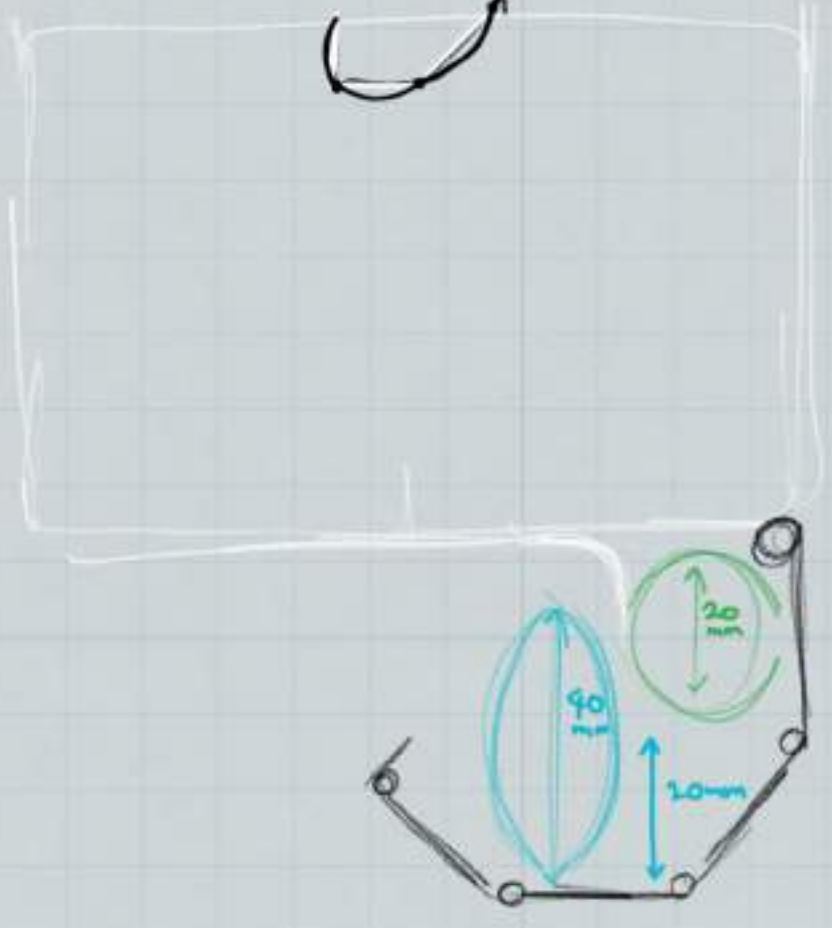
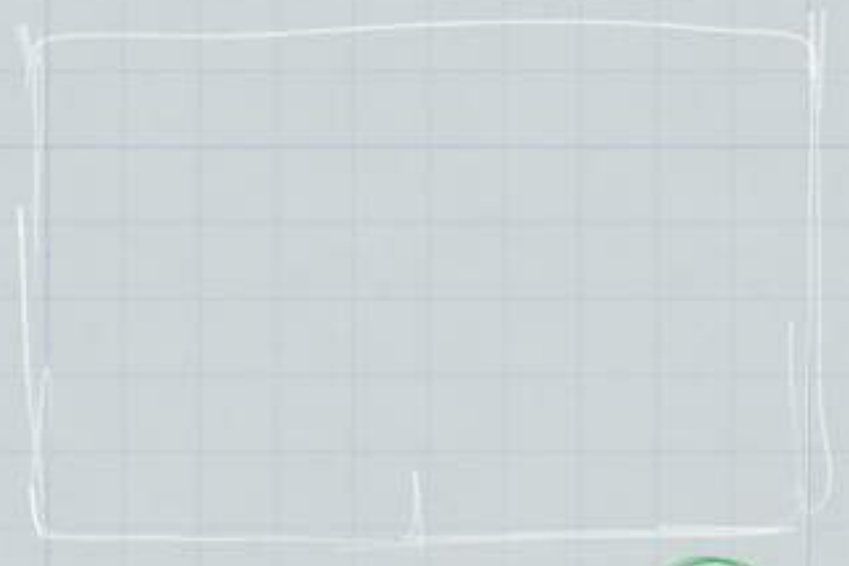
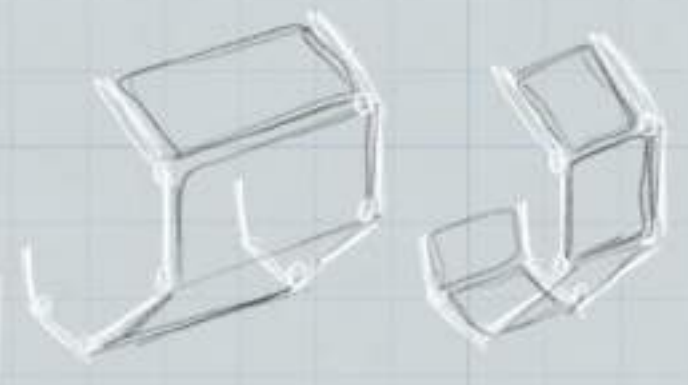
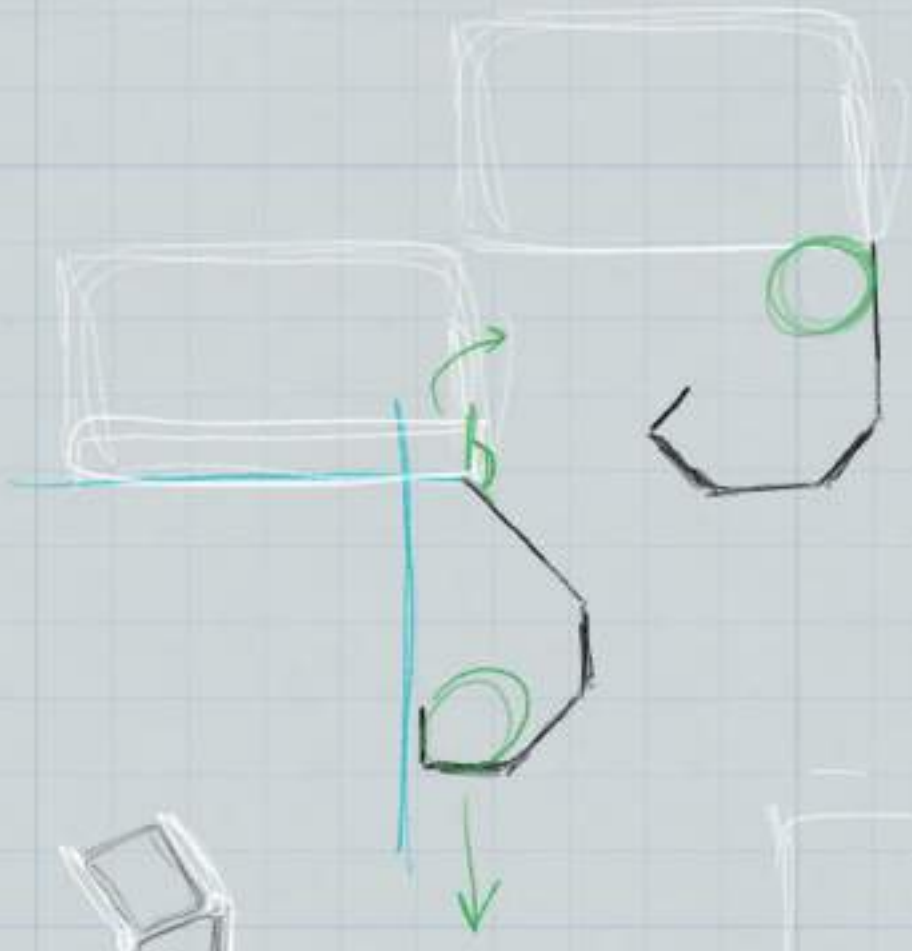
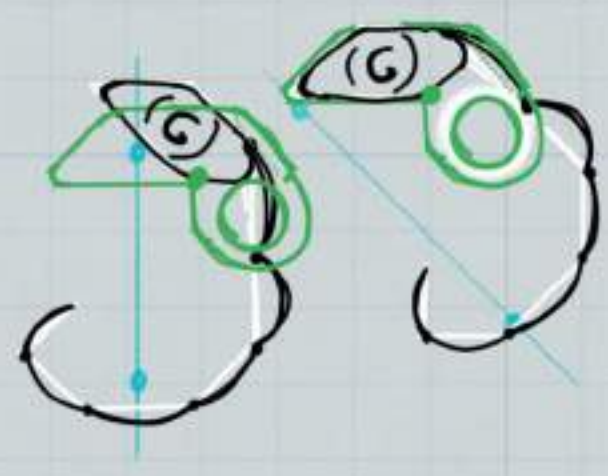

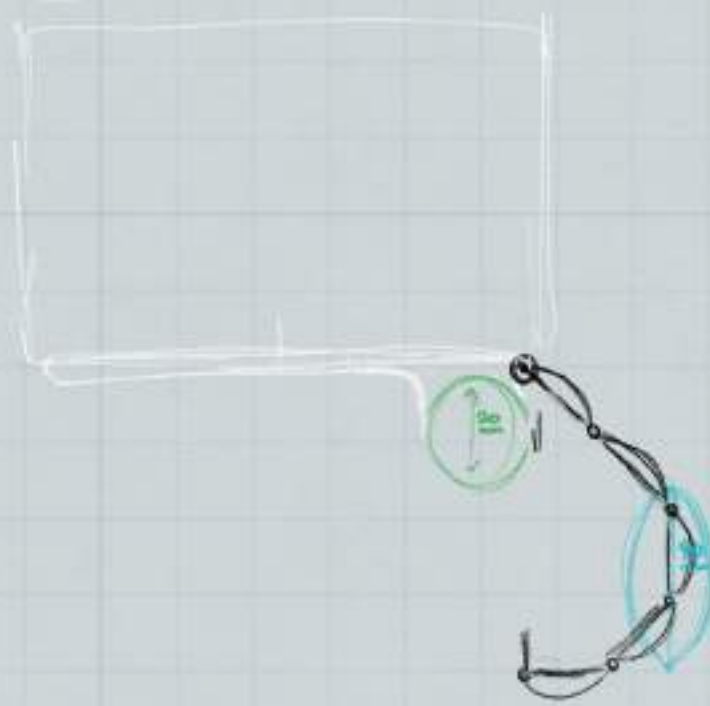
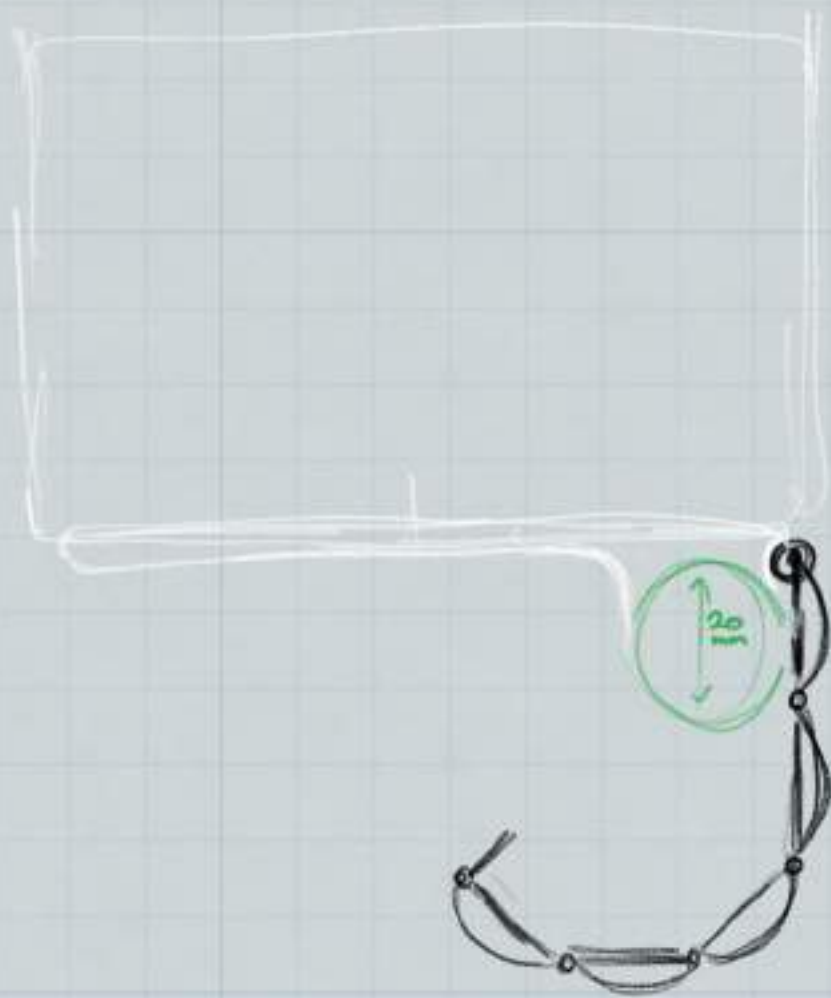

HARD
STEEL BIT

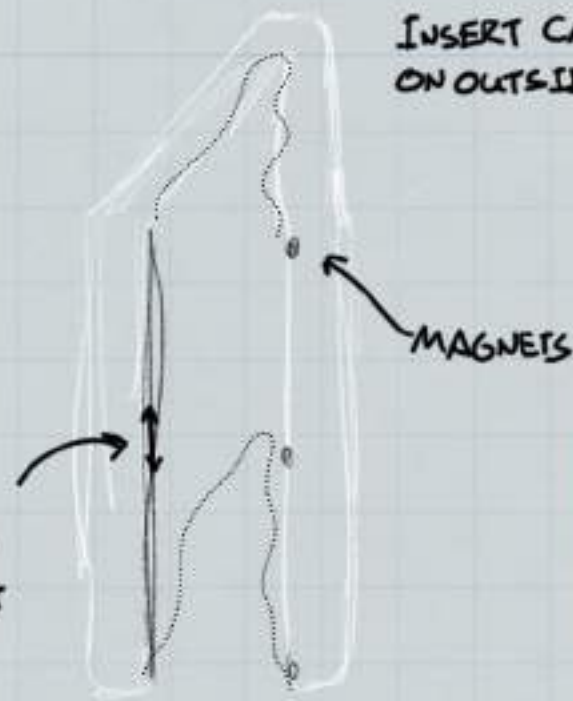

INSERT CARDS
ON OUTSIDE

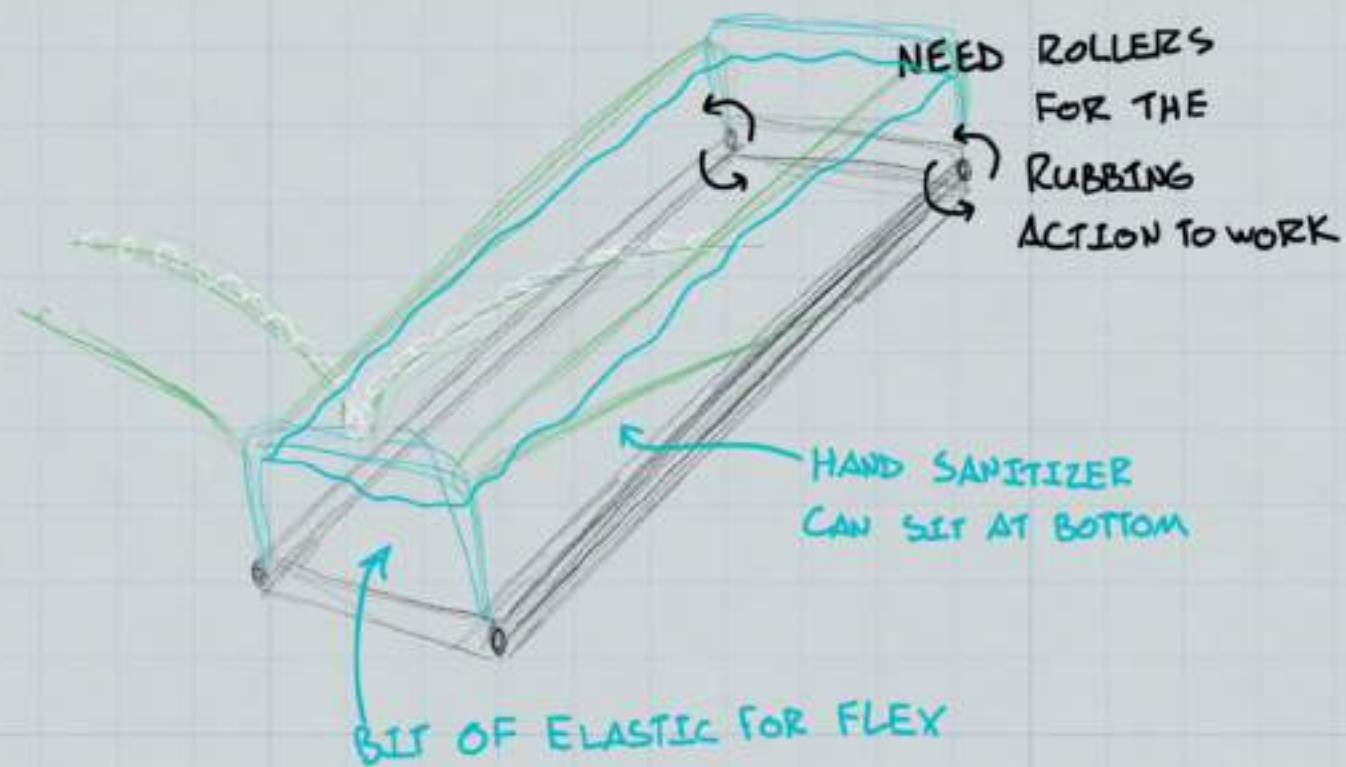
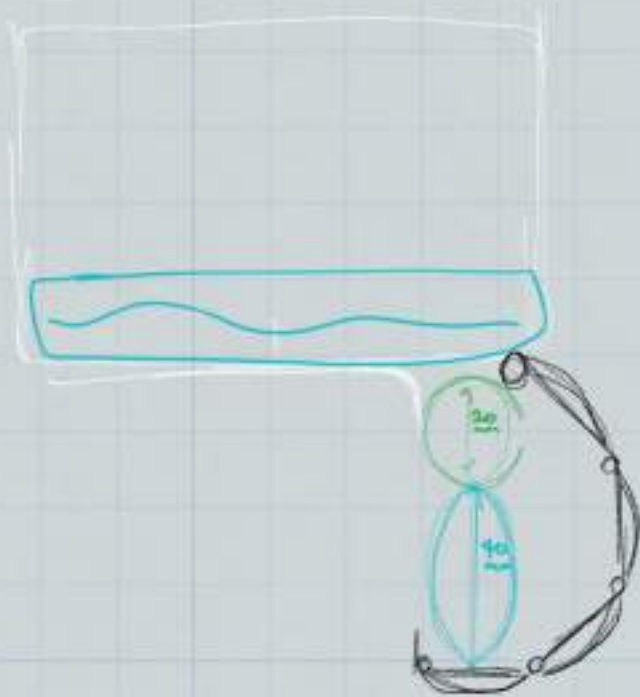
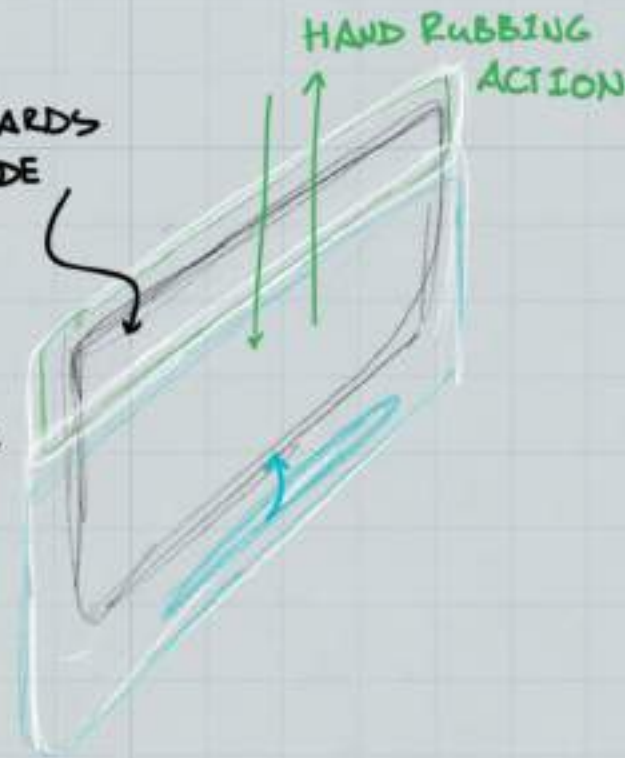

A WASHABLE HANKERCHIEF
WALLET



CARD SLIP IN MIDDLE

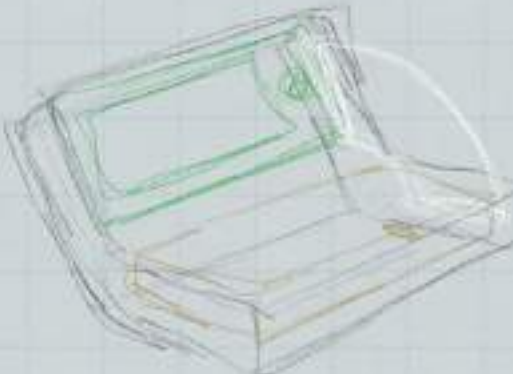
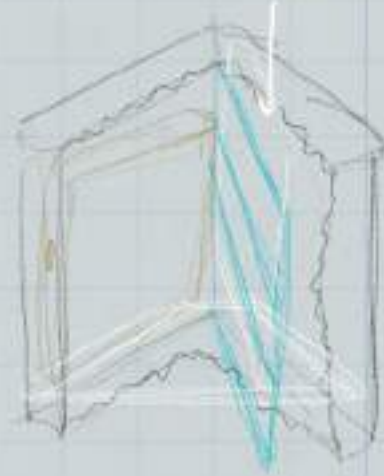

FOR SPINNING
THE WALLET
→ A FLAP STICKS
OUT AND YOU
CATCH IT
LIKE THIS

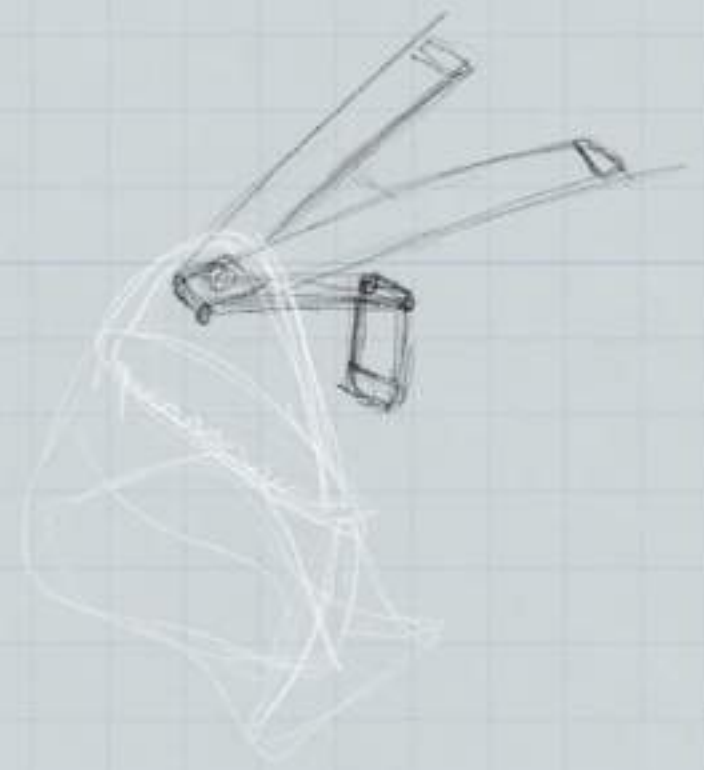
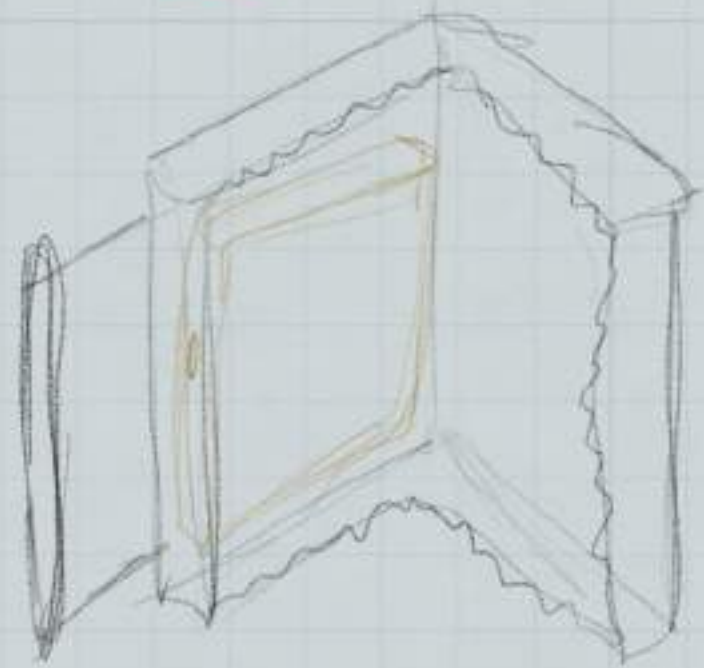
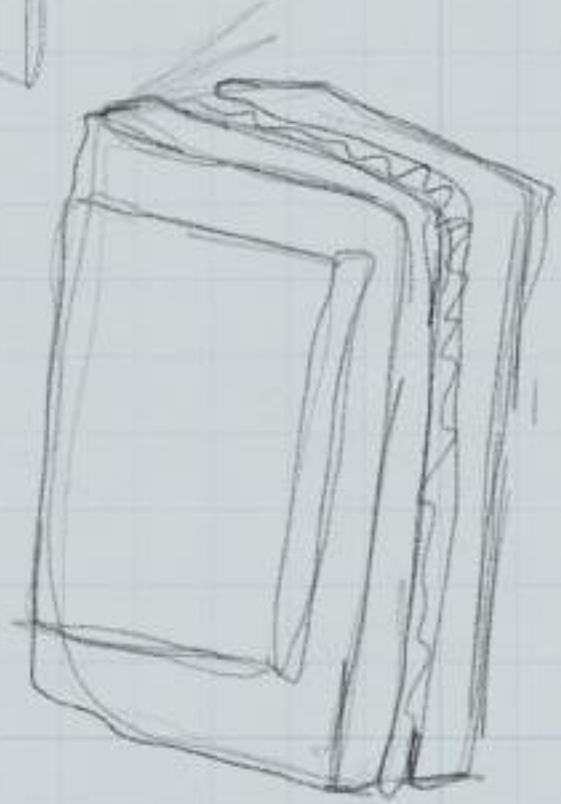
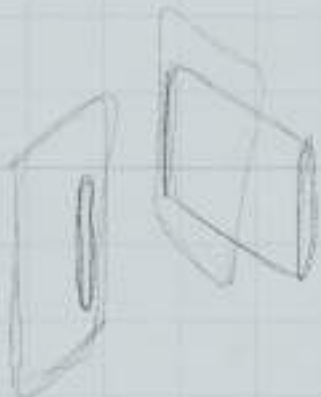

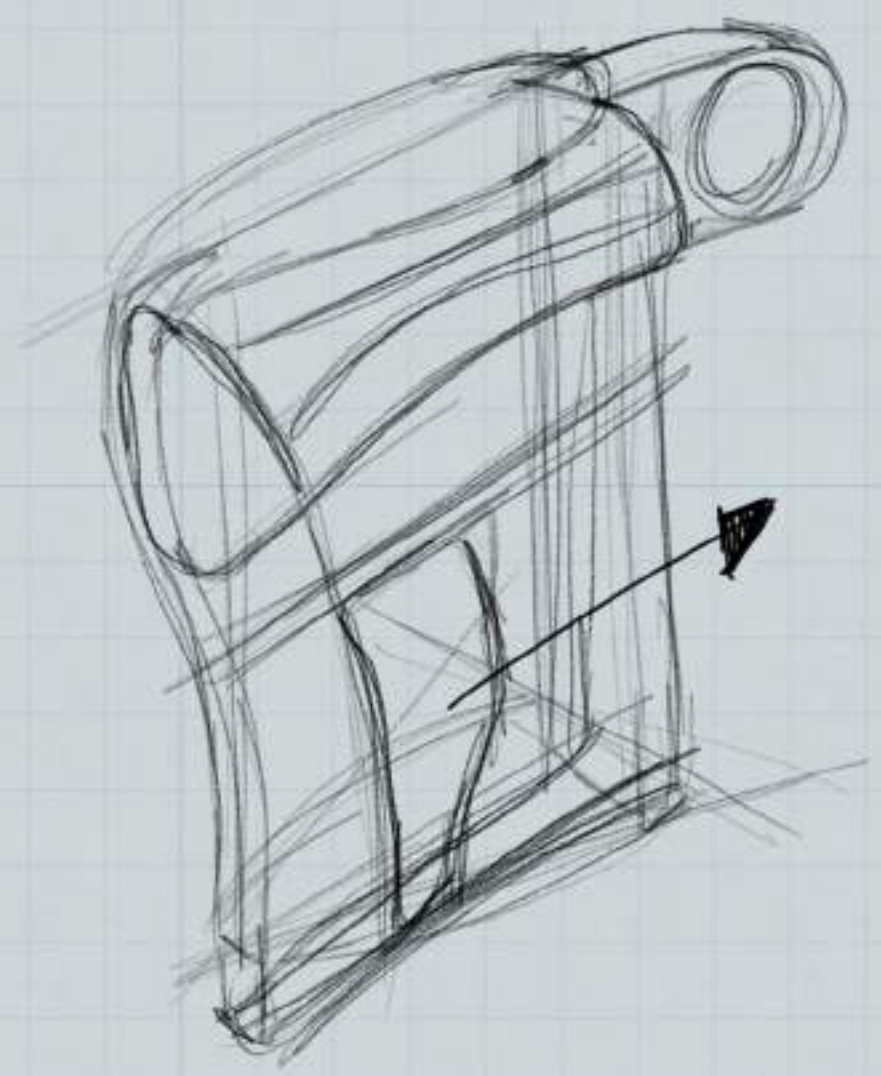
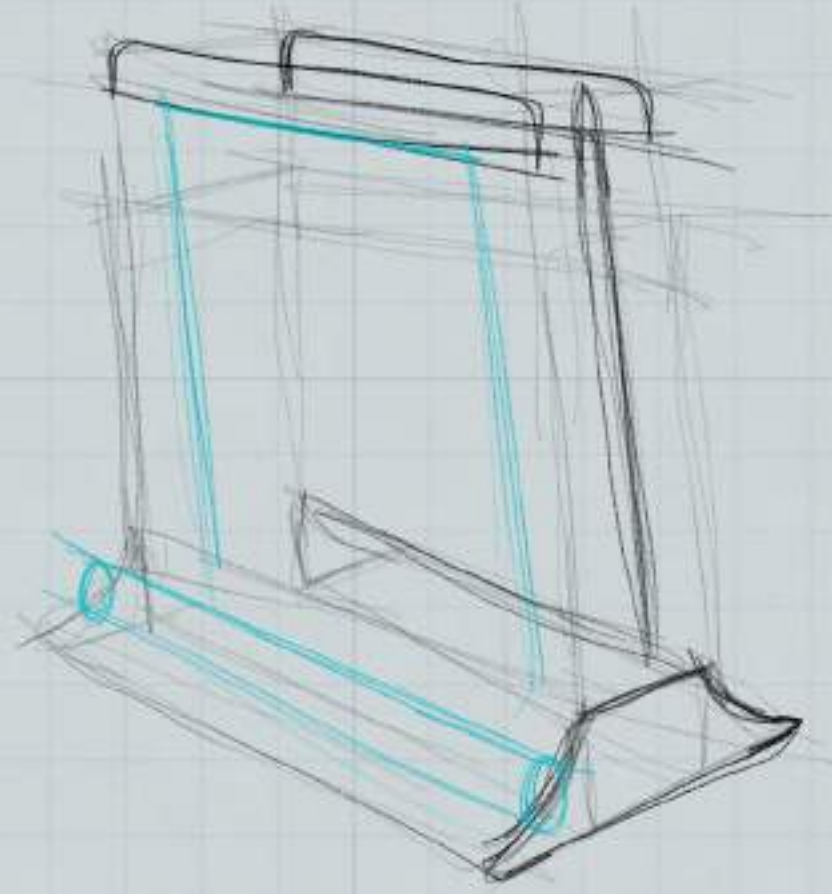
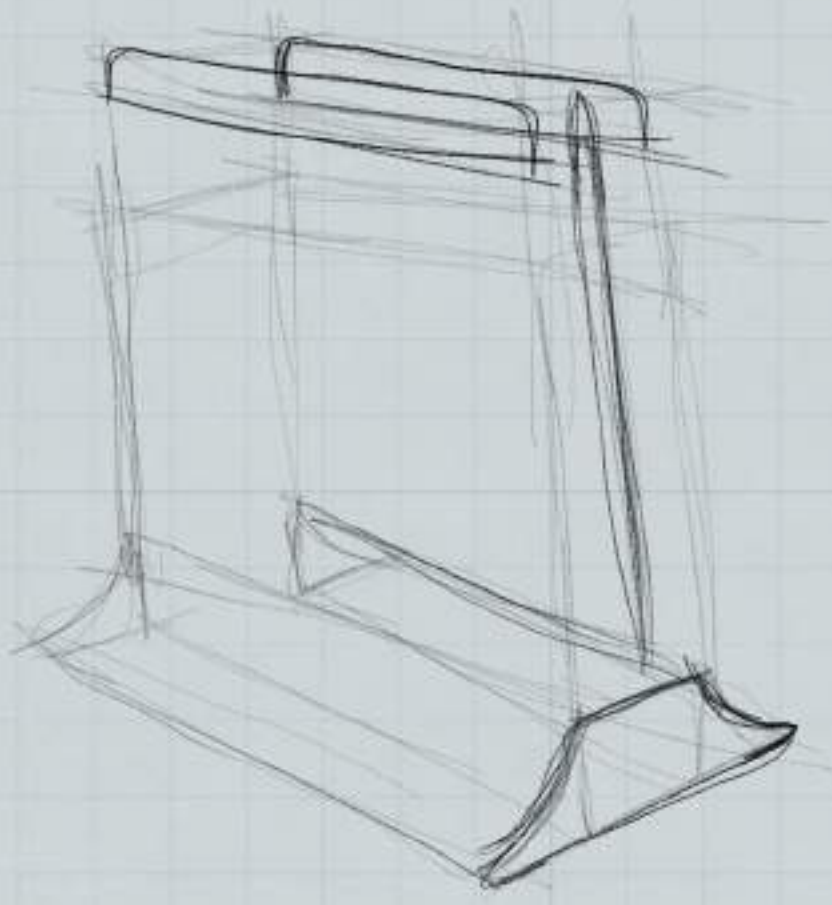
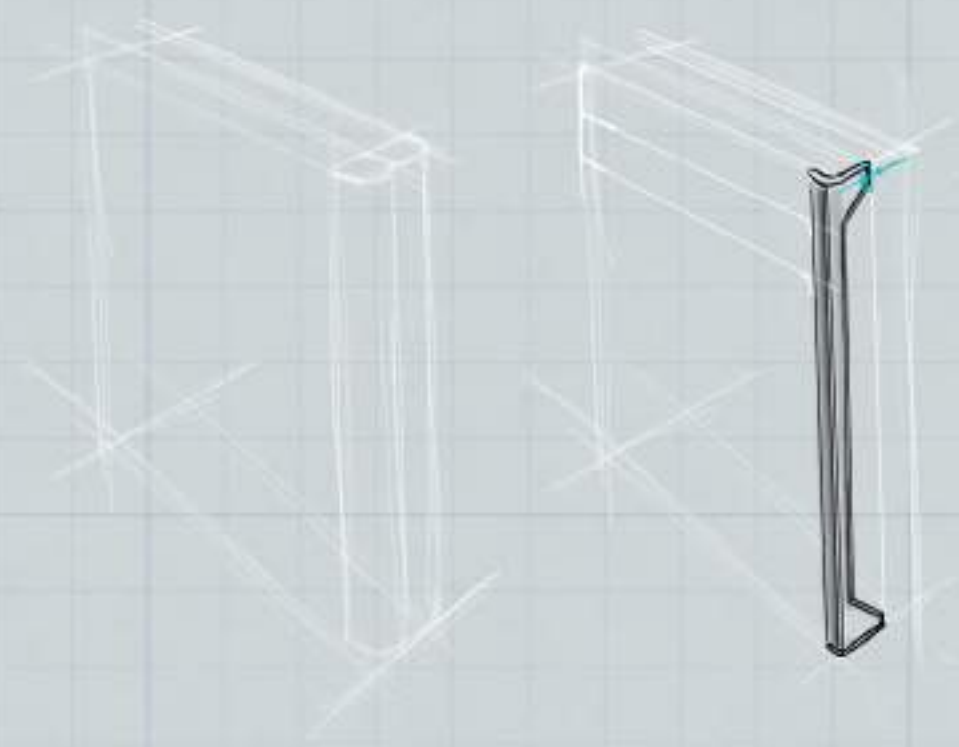

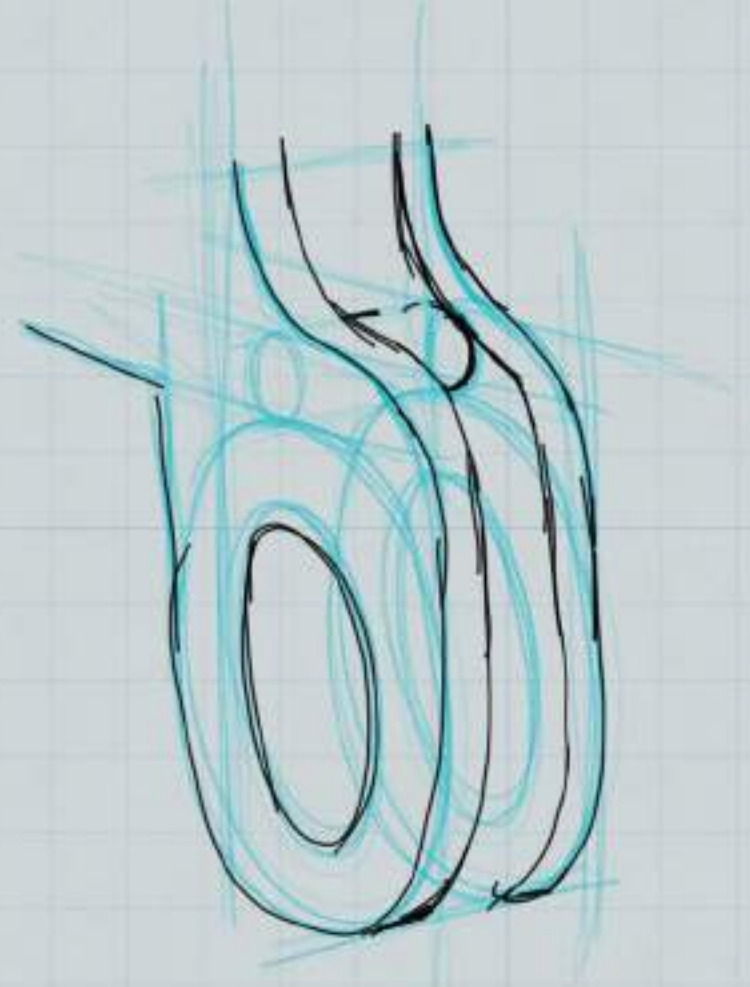
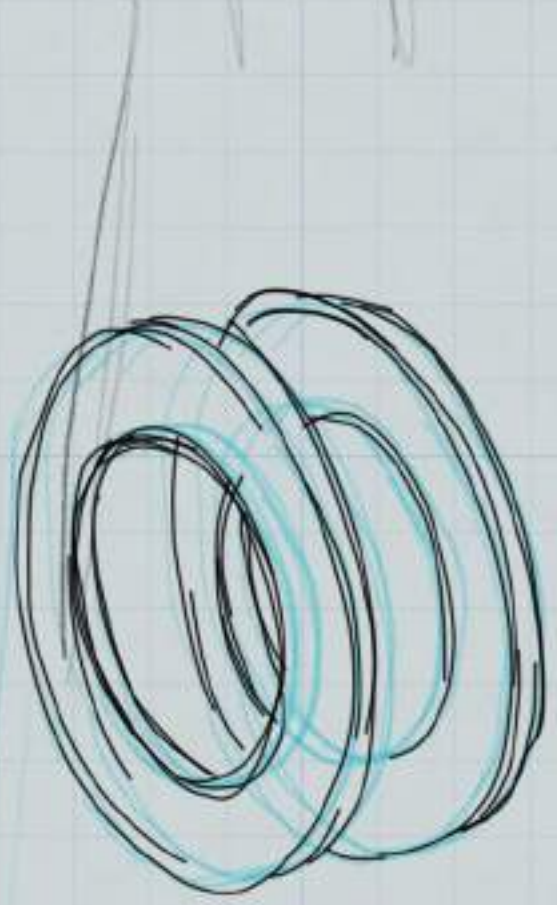
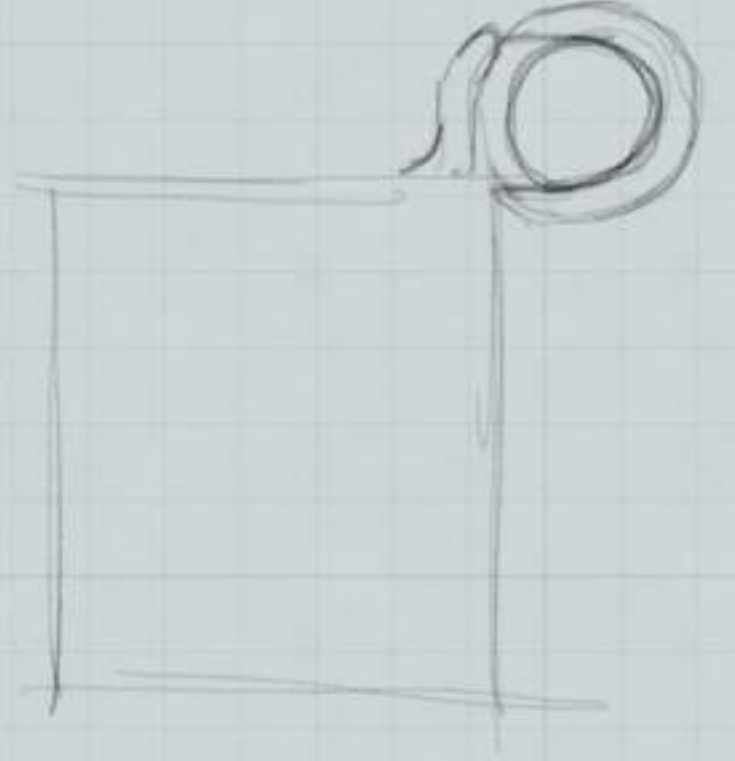
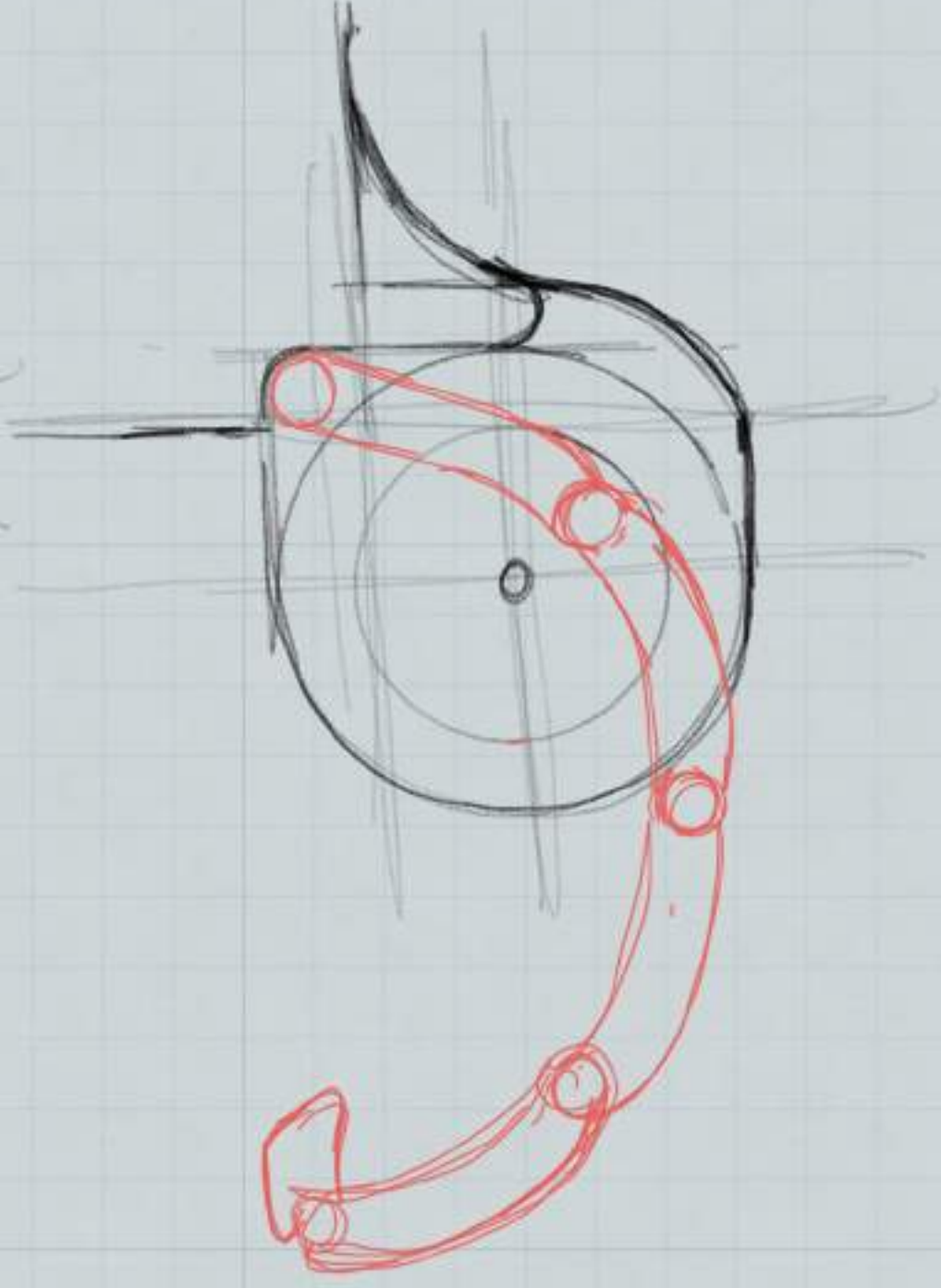
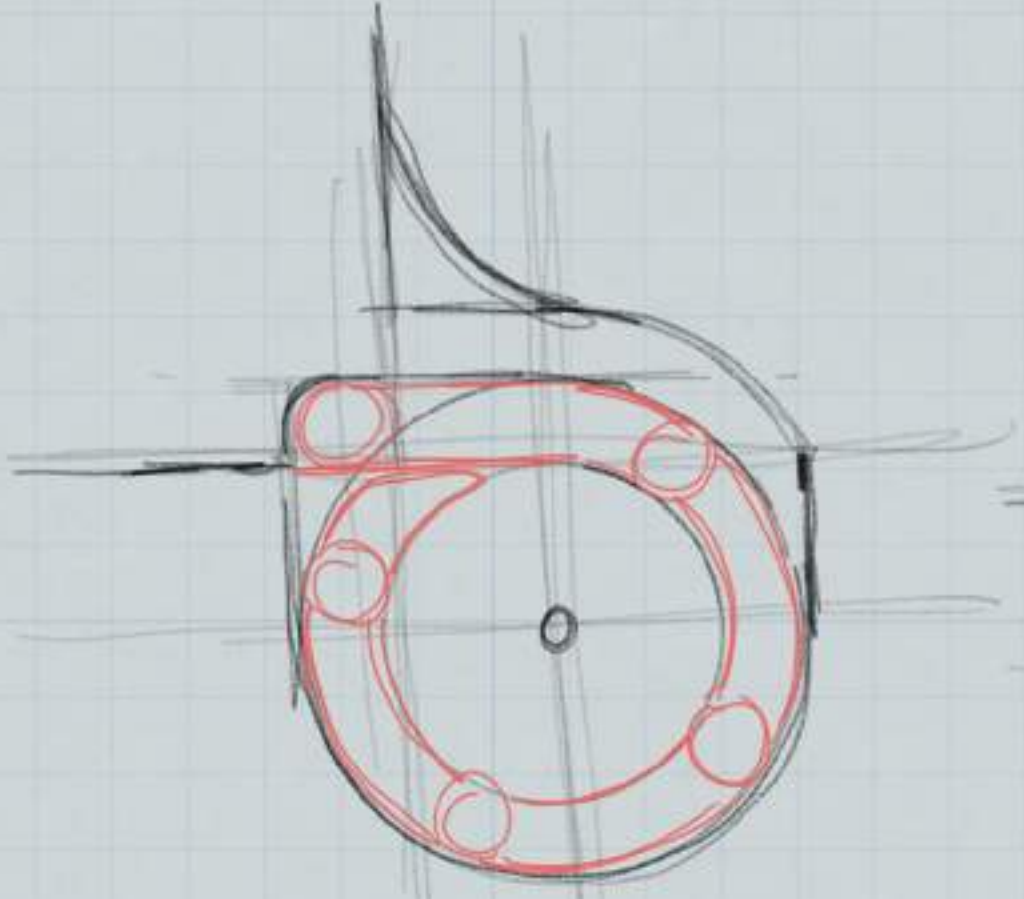

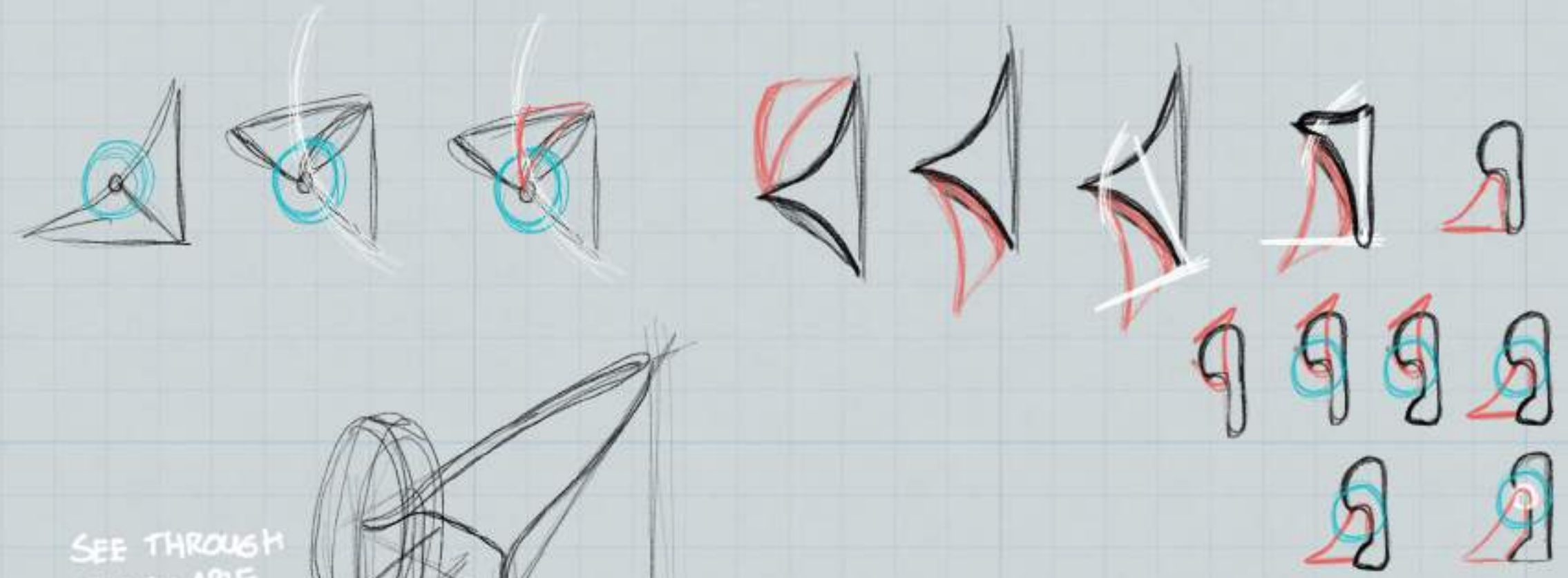
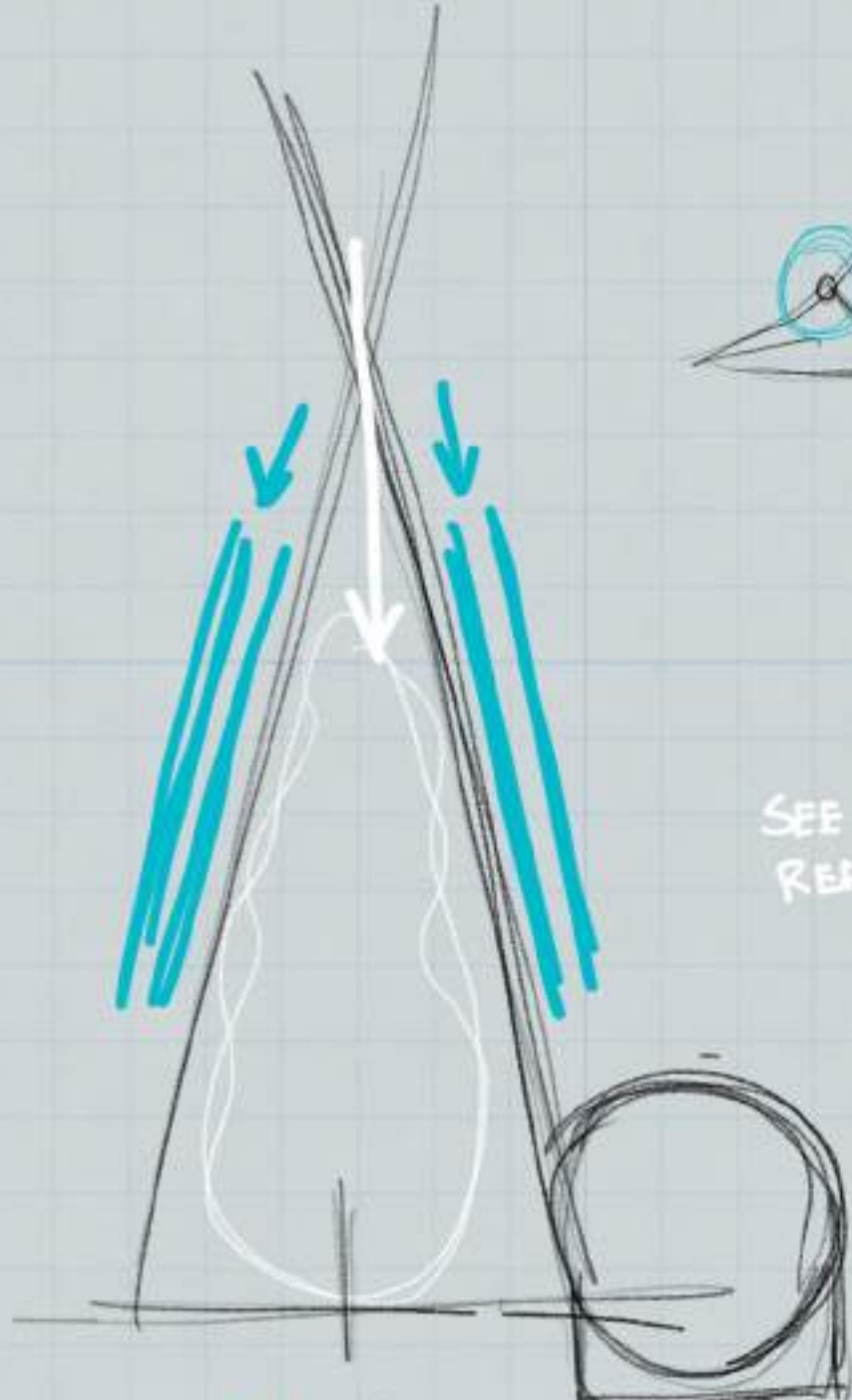

SEE THROUGH
REFILLABLE

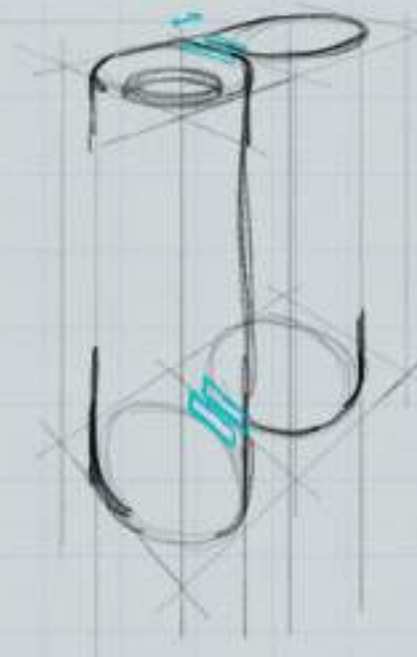
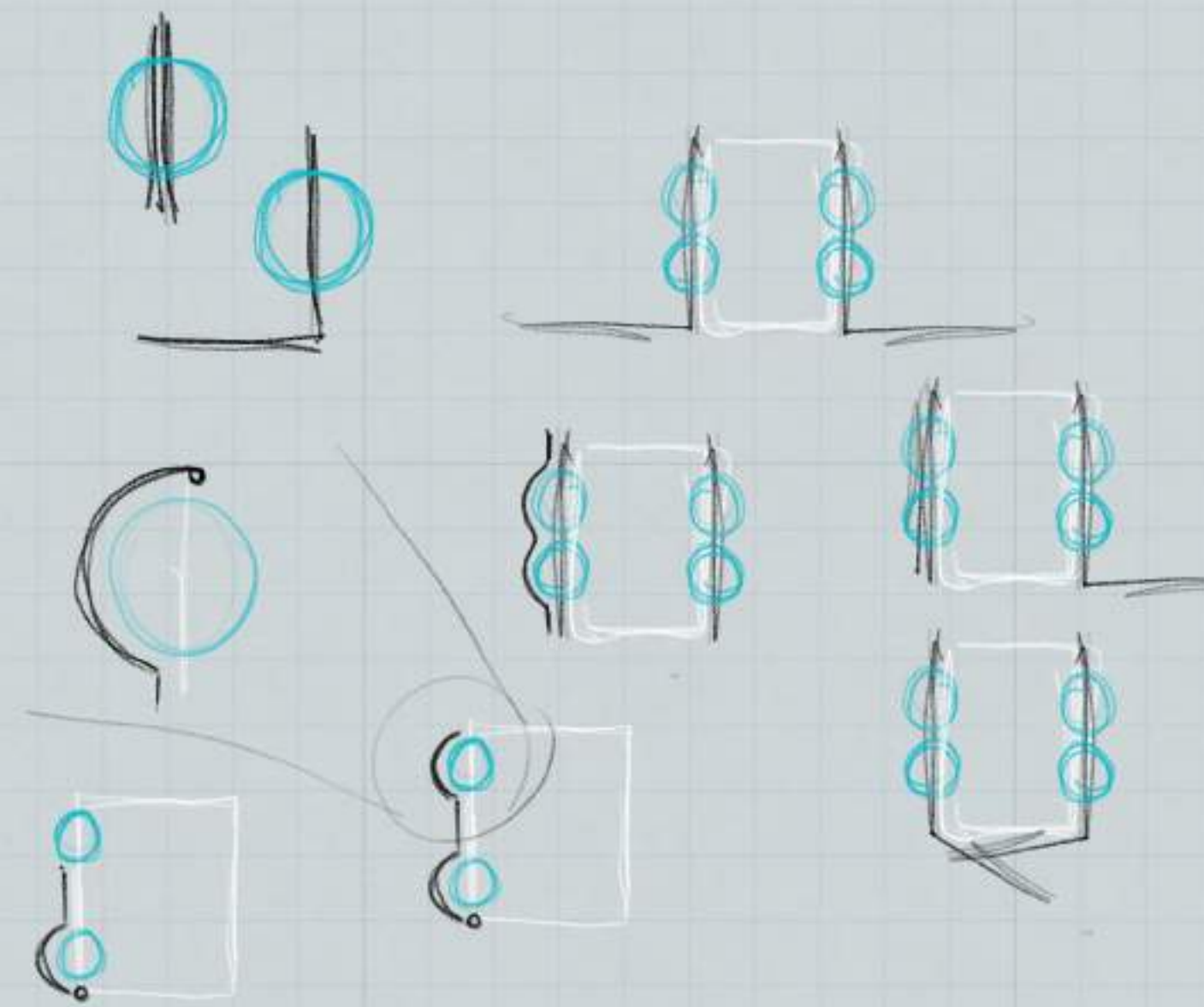
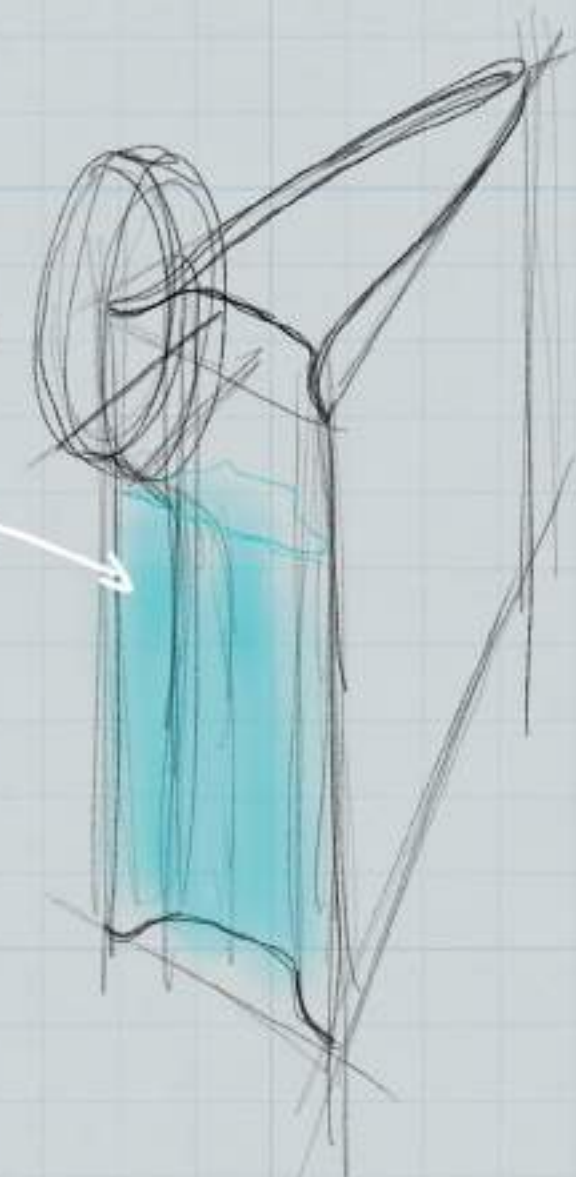

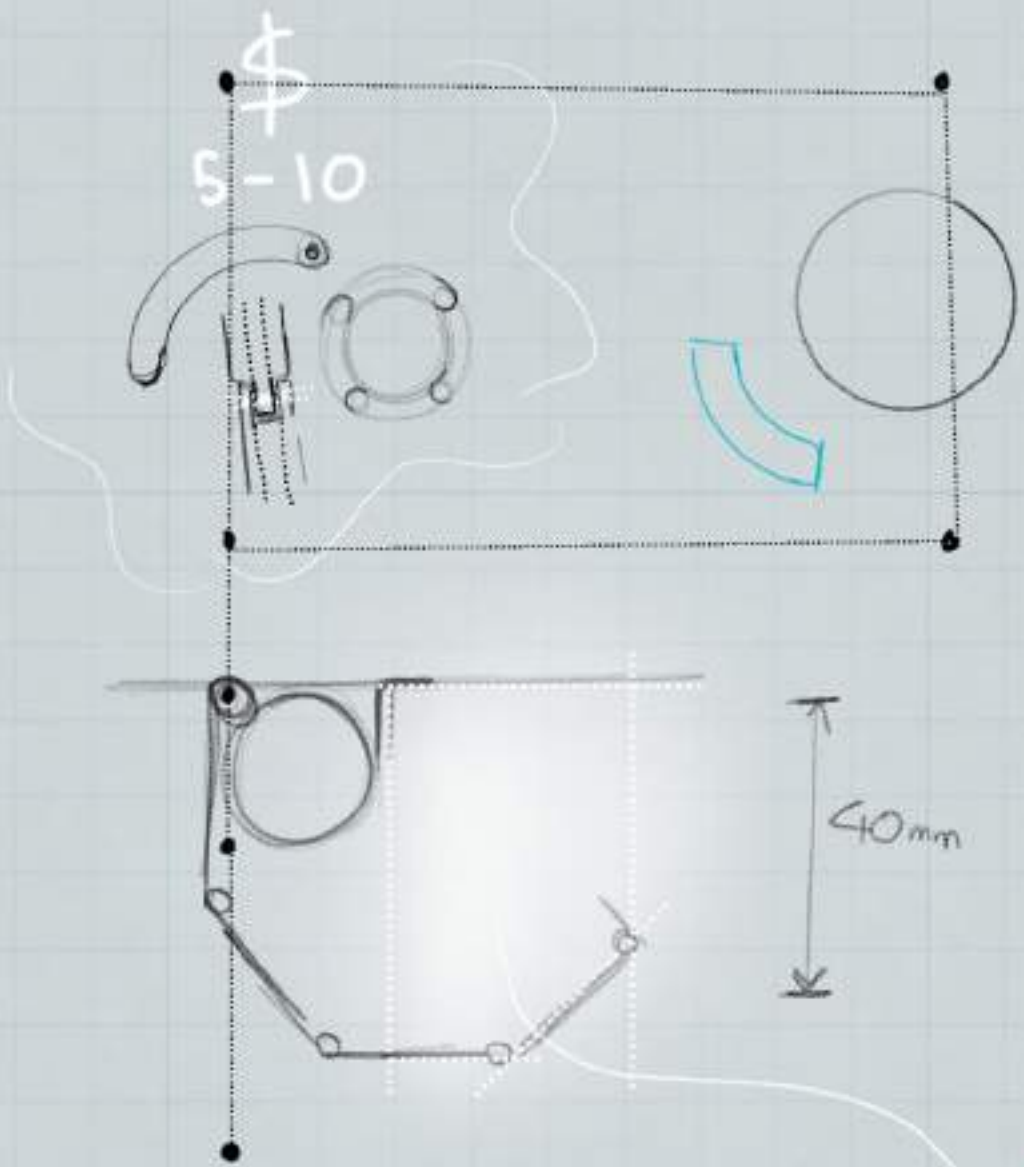

$$2\pi r = C = 90\text{mm}$$

$$r = \frac{C}{2\pi} = 14.32\text{mm}$$

$$\therefore d = 28.65\text{mm}$$



BAG HANDLE
 * SIZES
 * TYPES

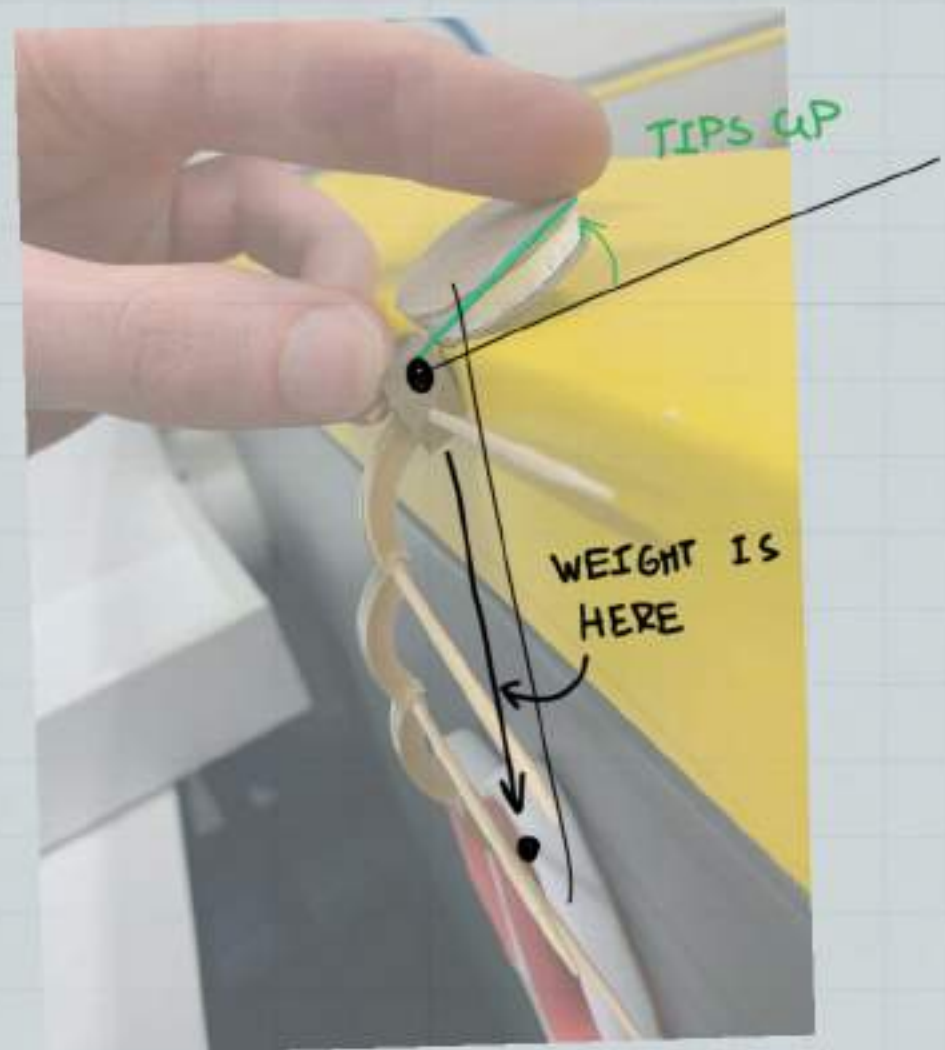
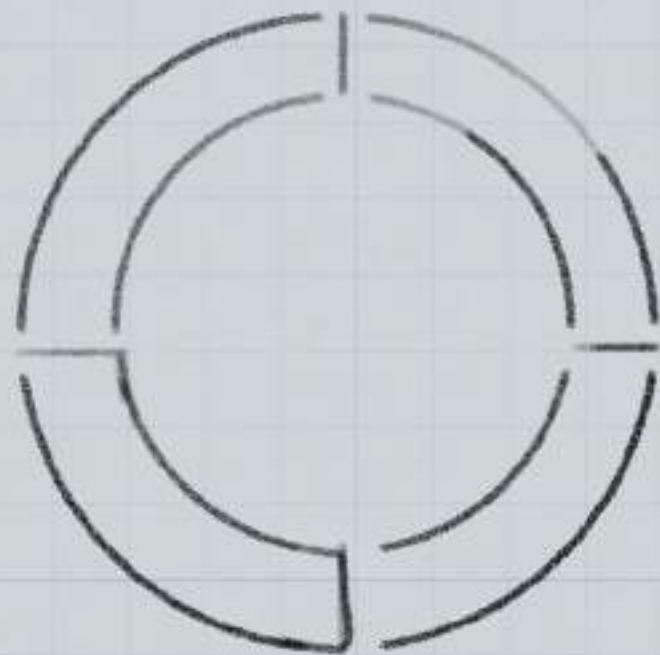
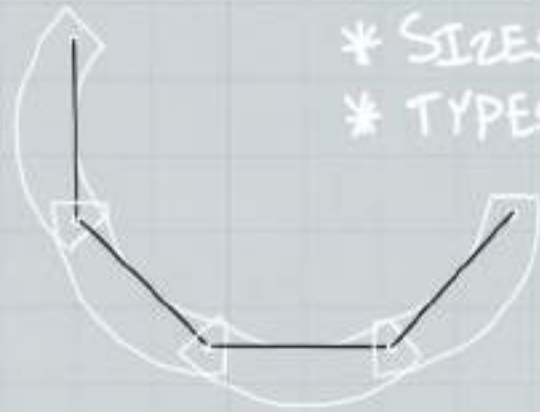

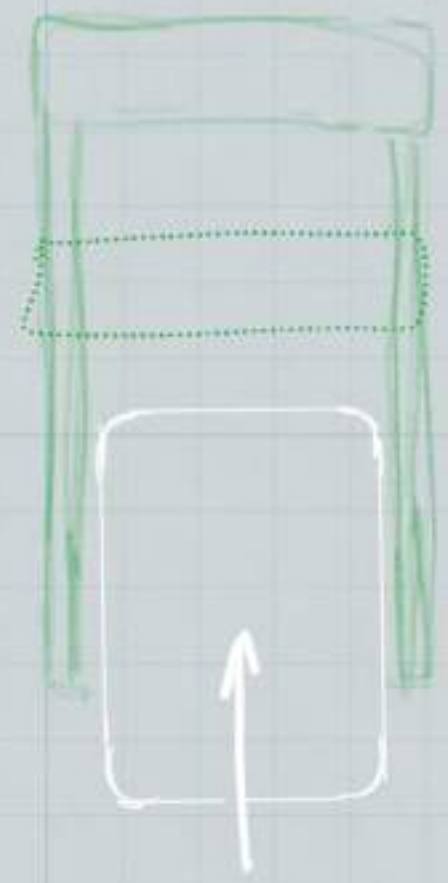
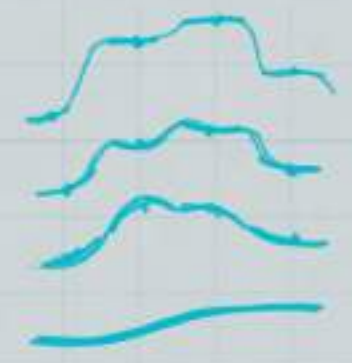
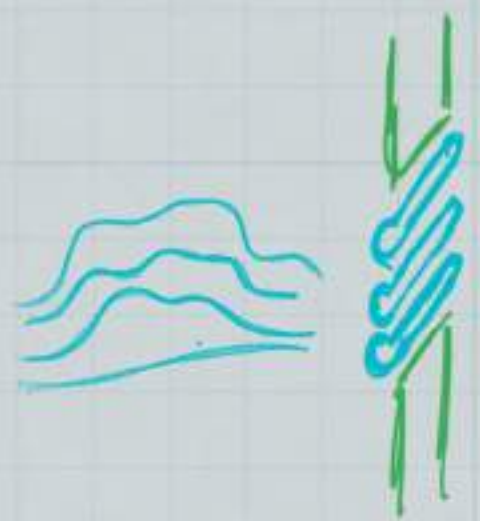
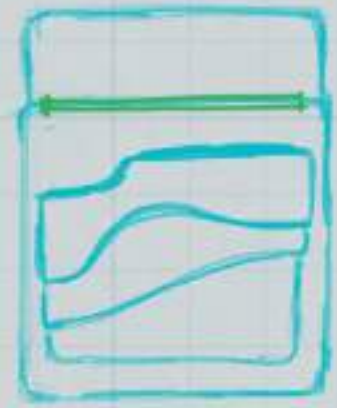
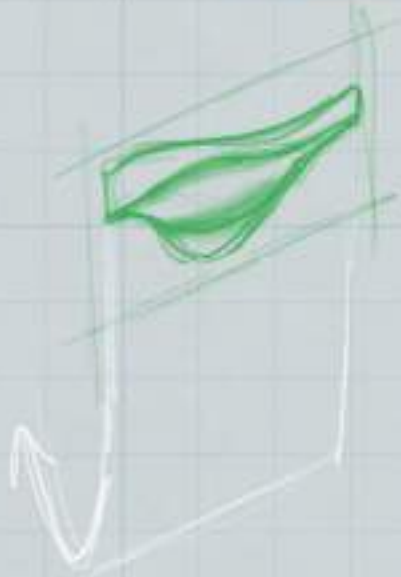
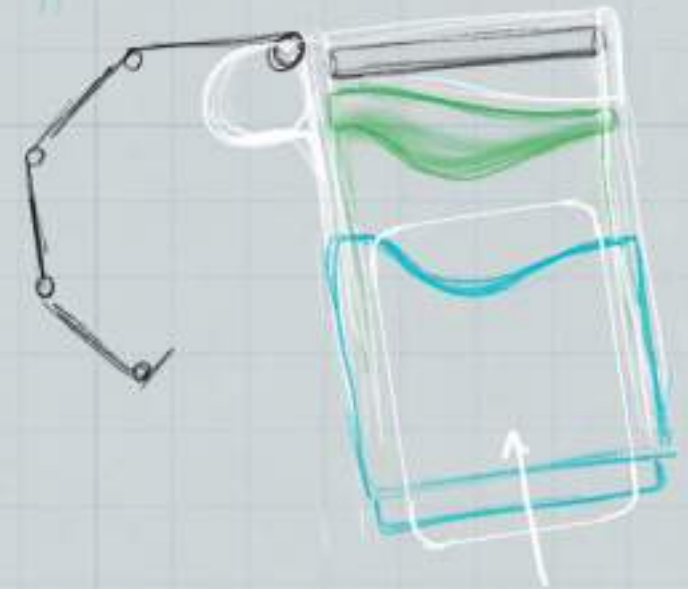
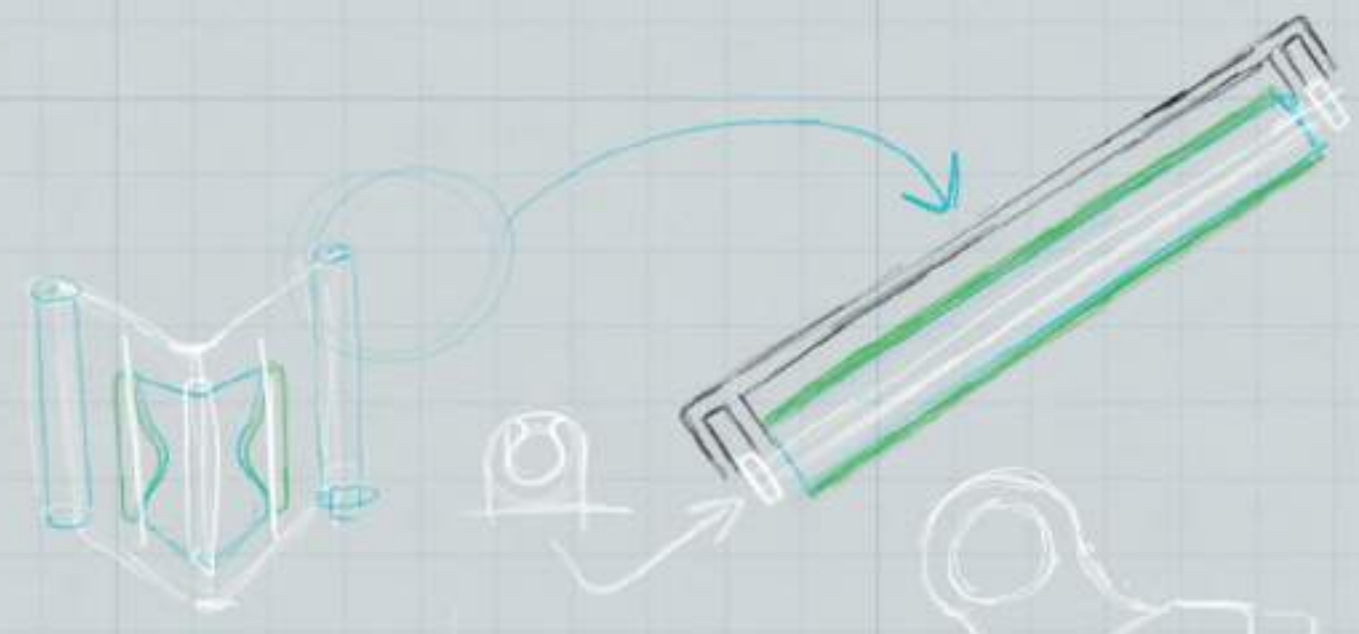
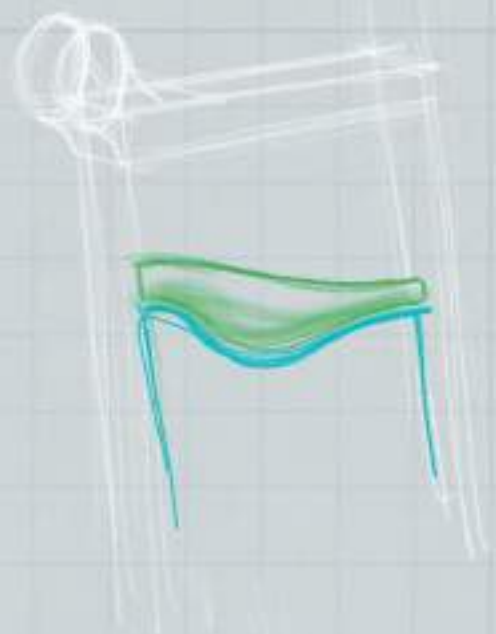
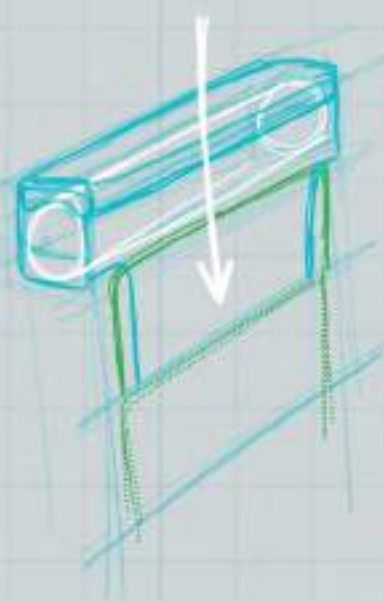



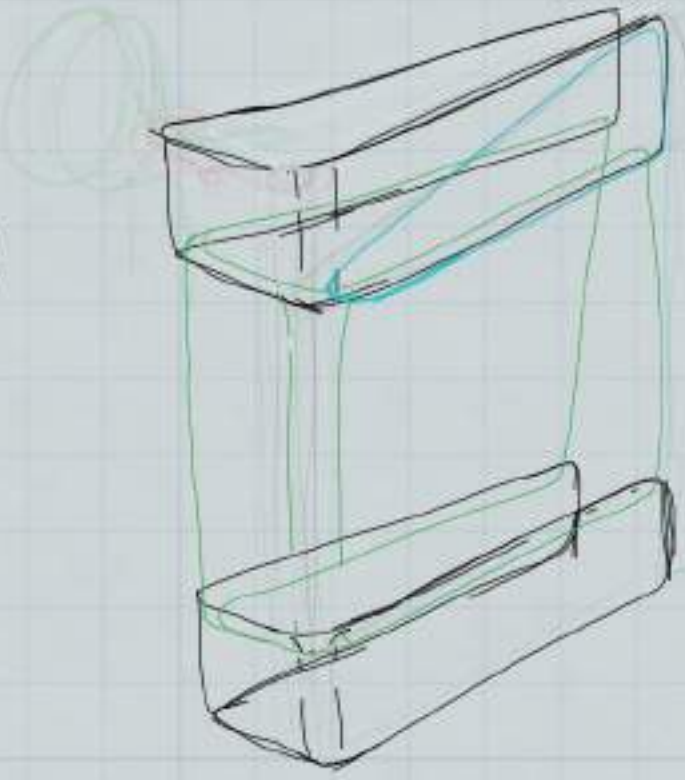
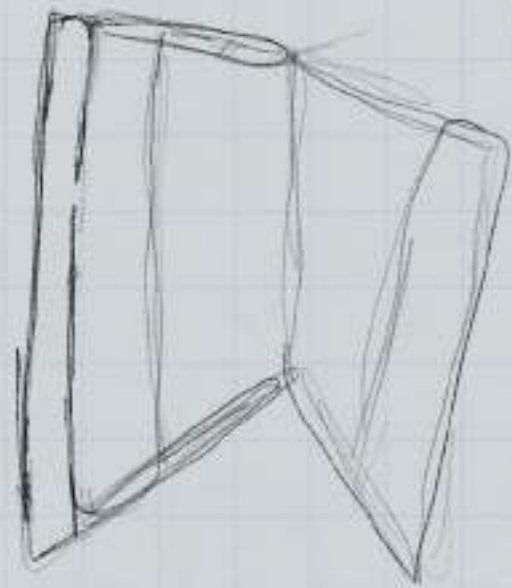

CLEAR?

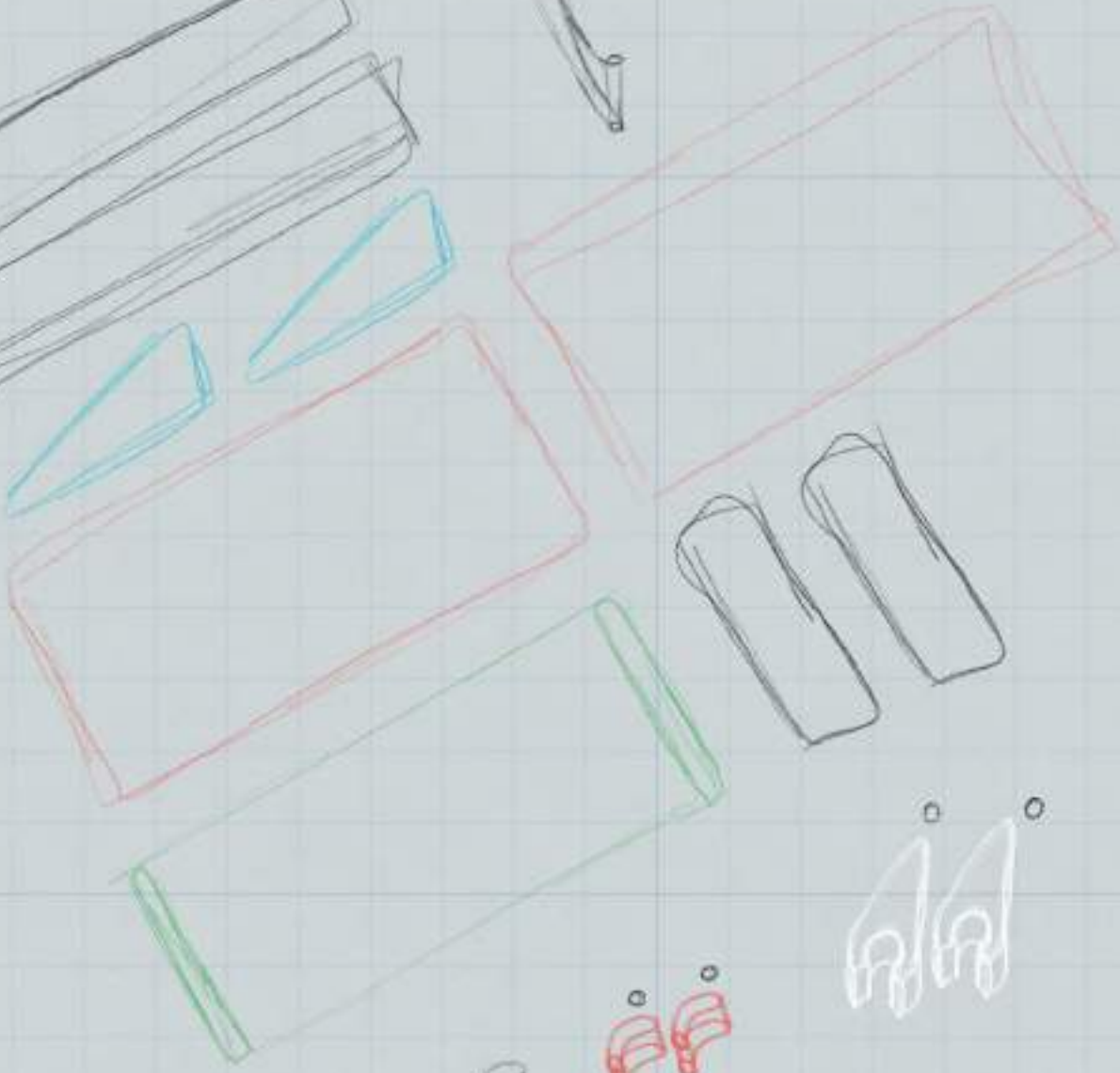

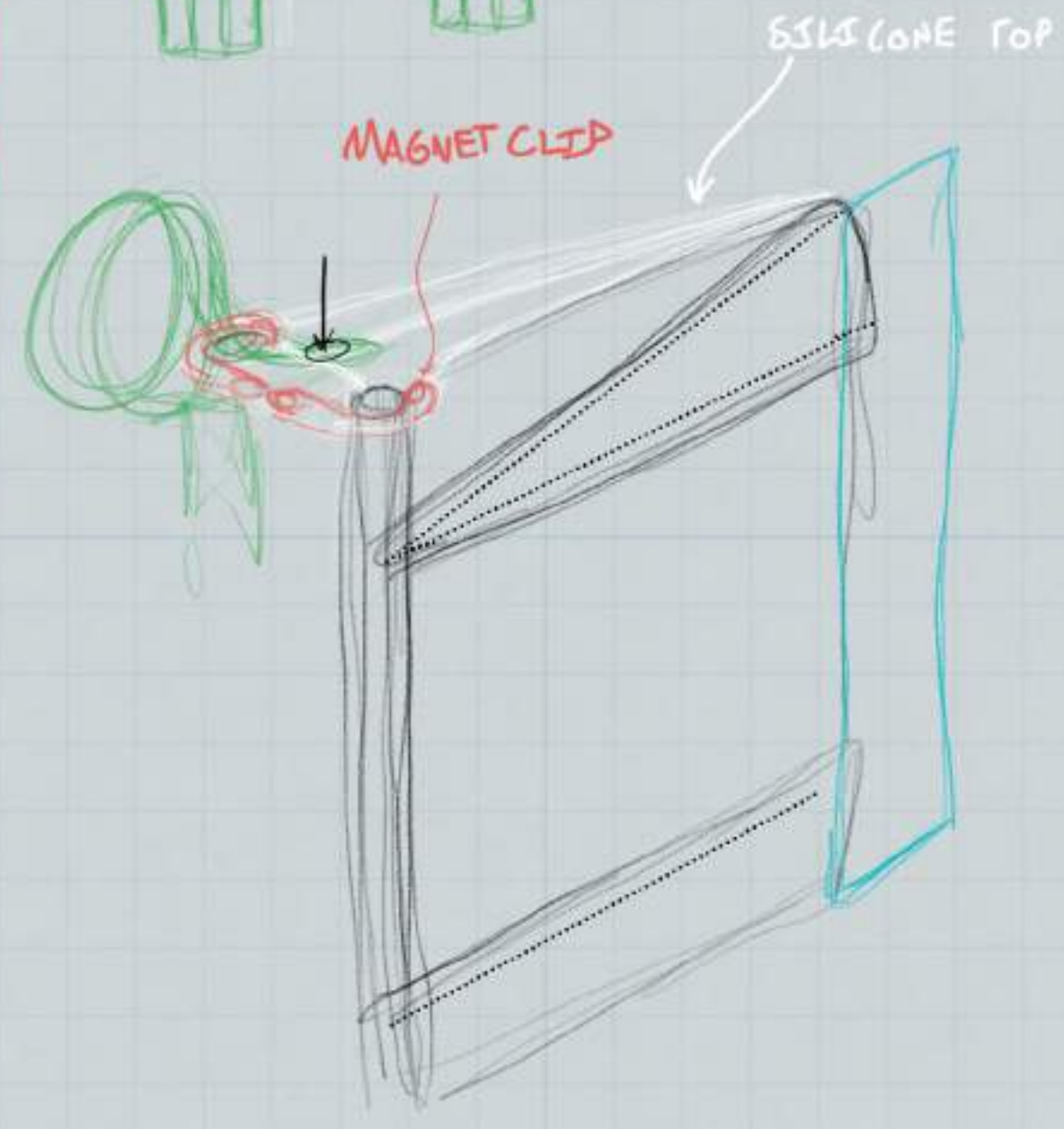
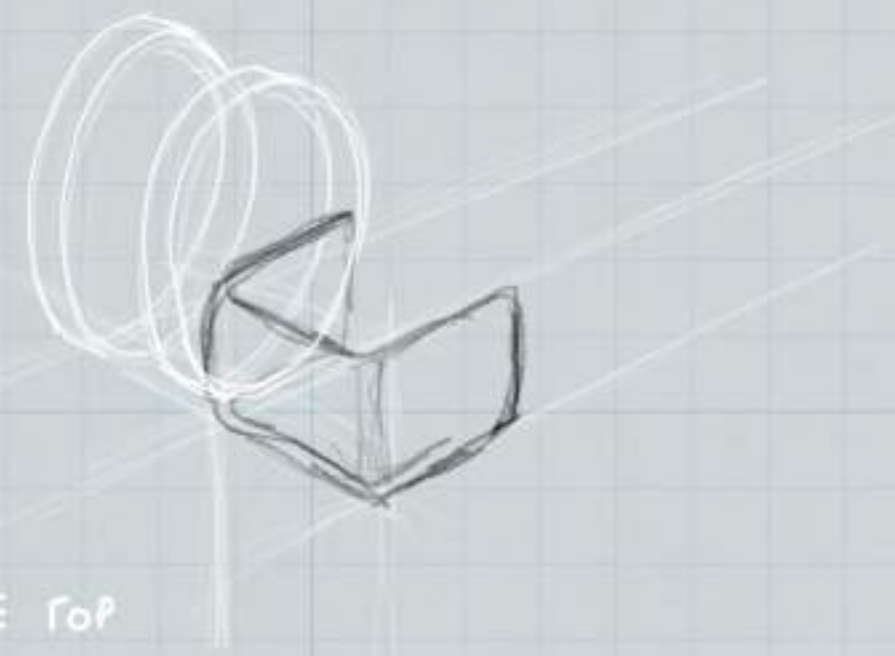
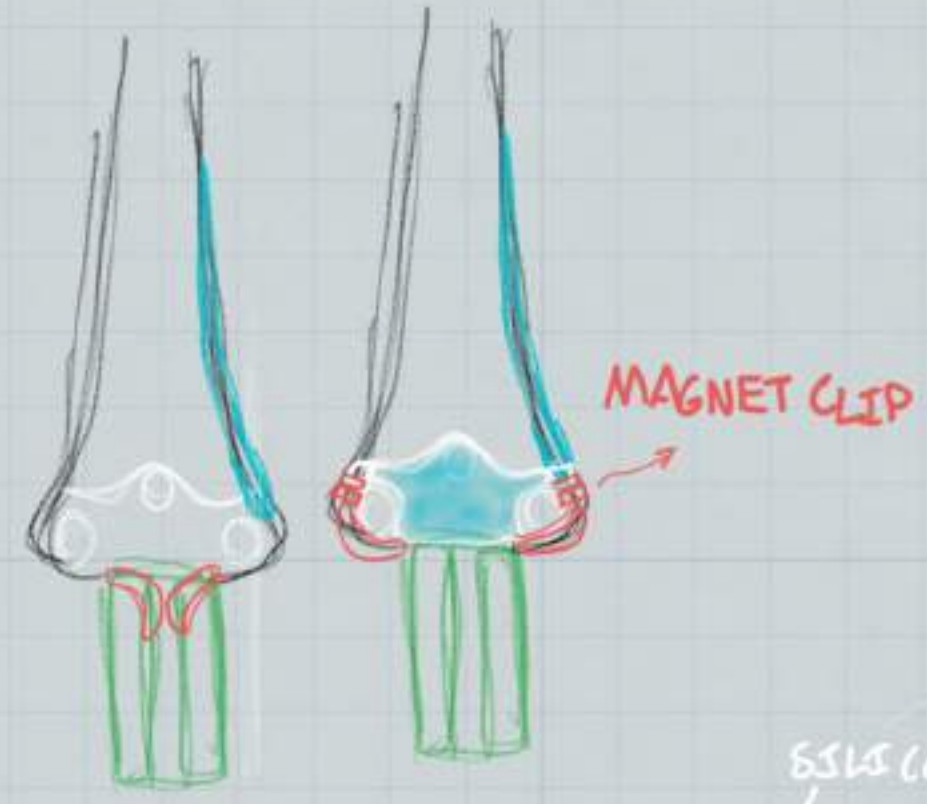
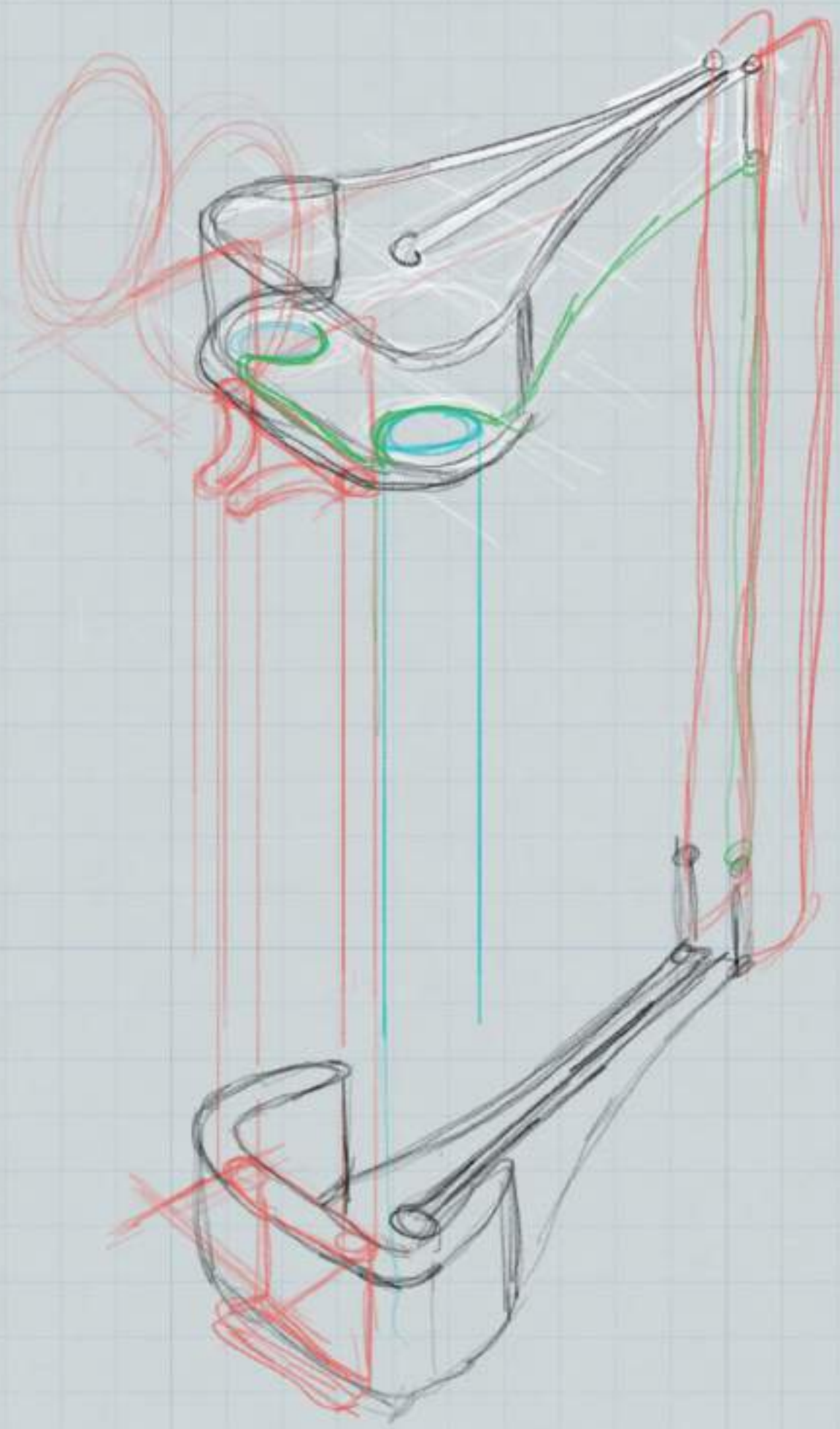

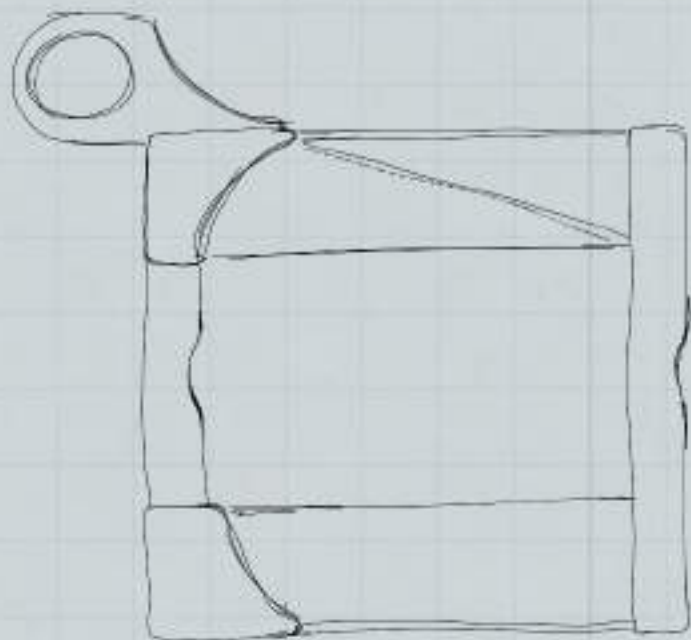
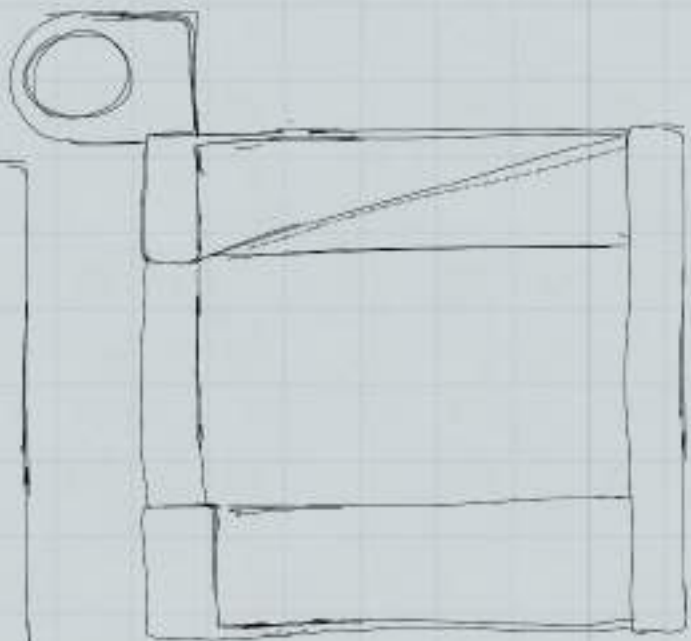
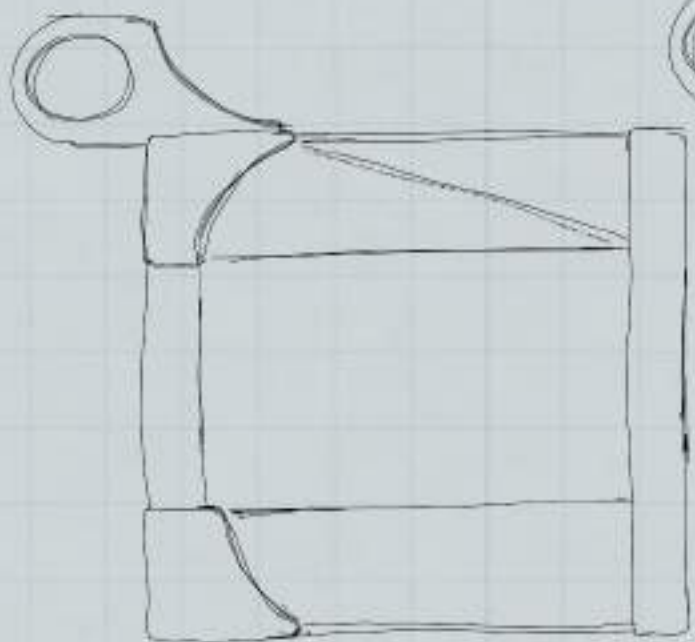
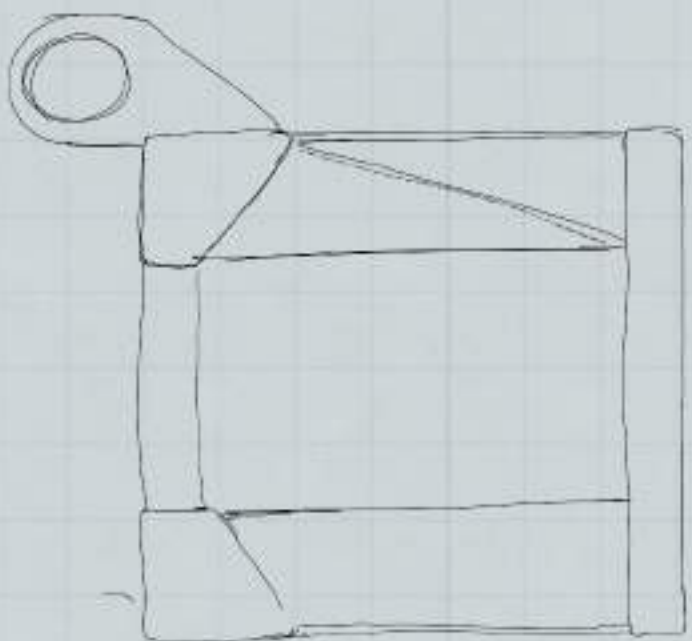
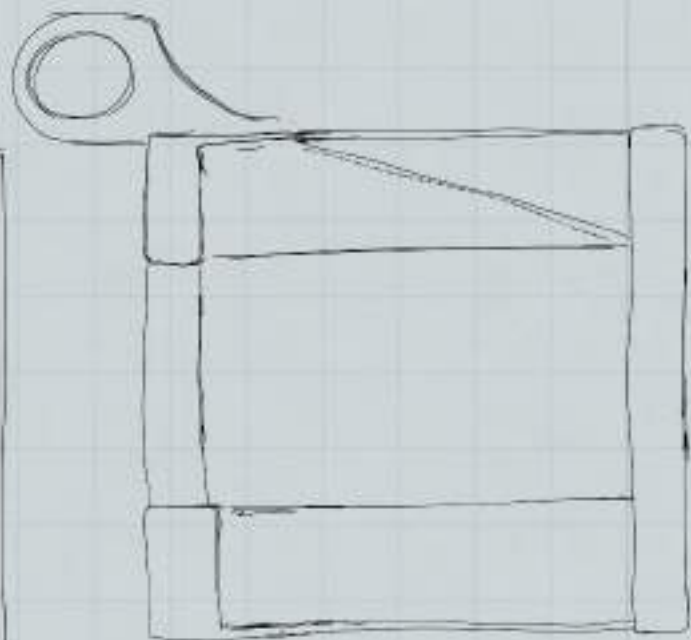
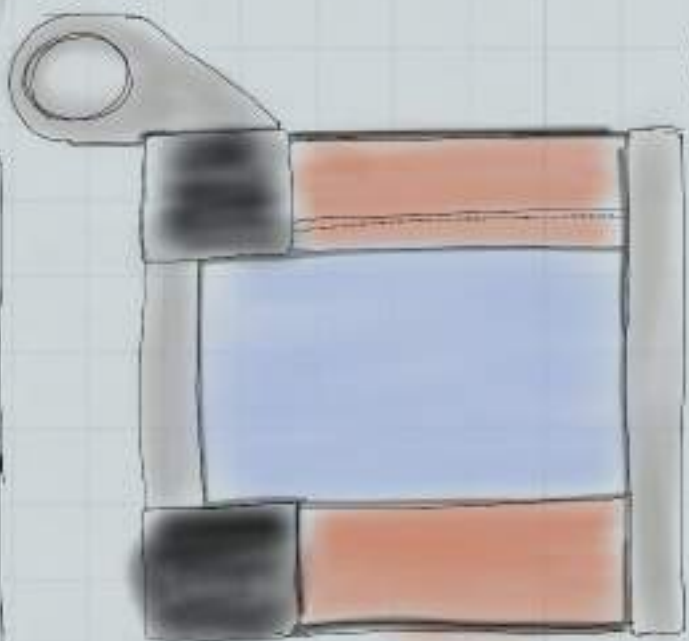
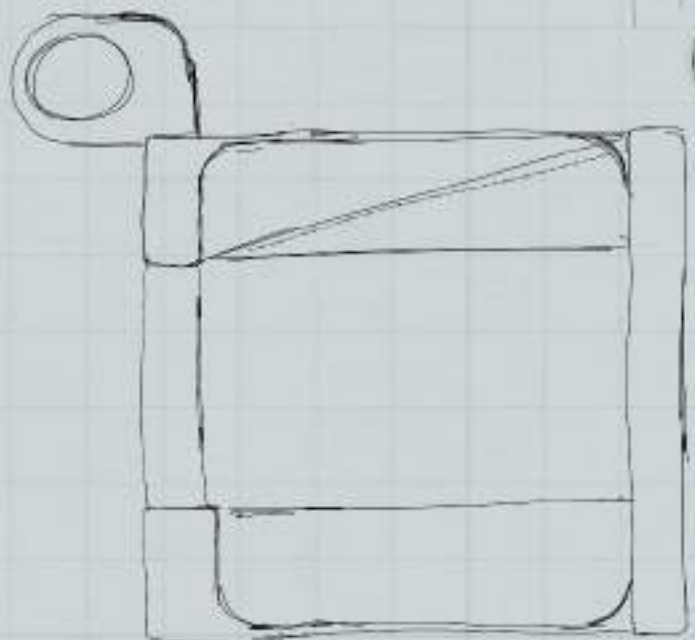
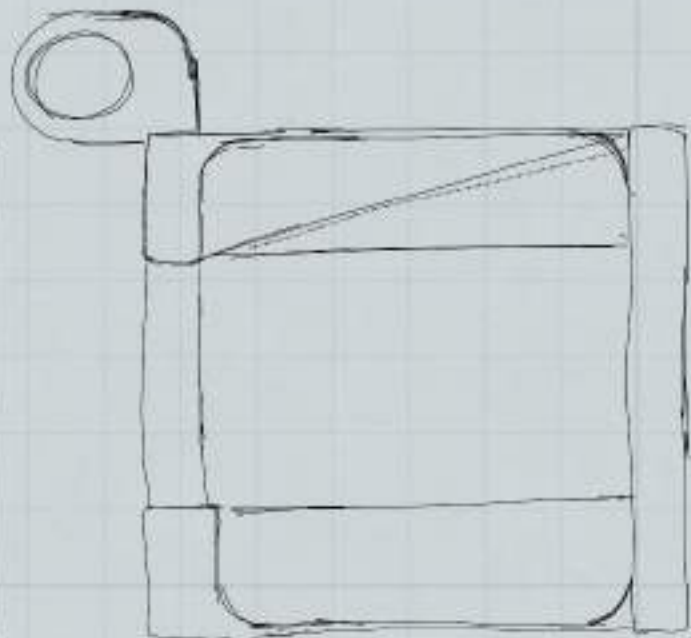
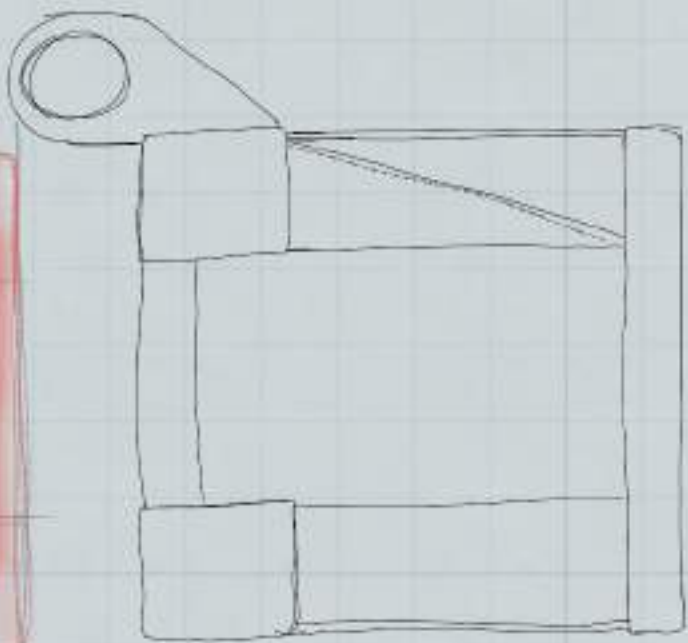
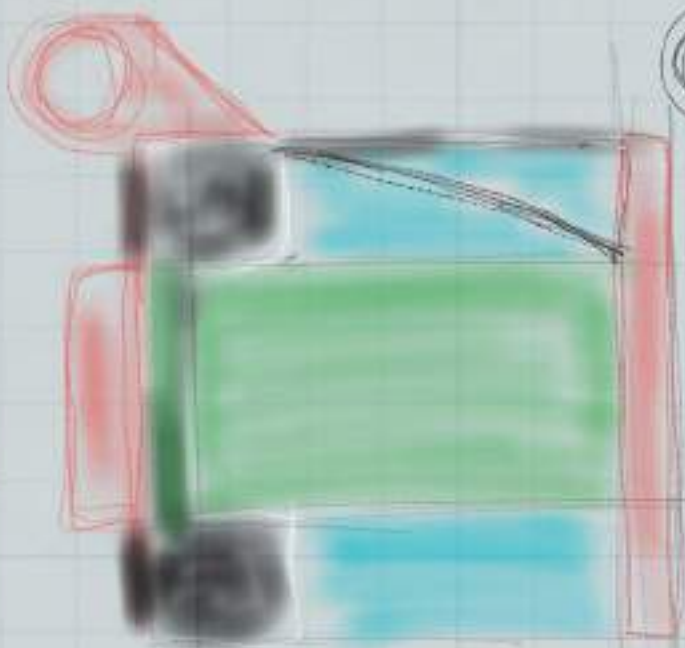
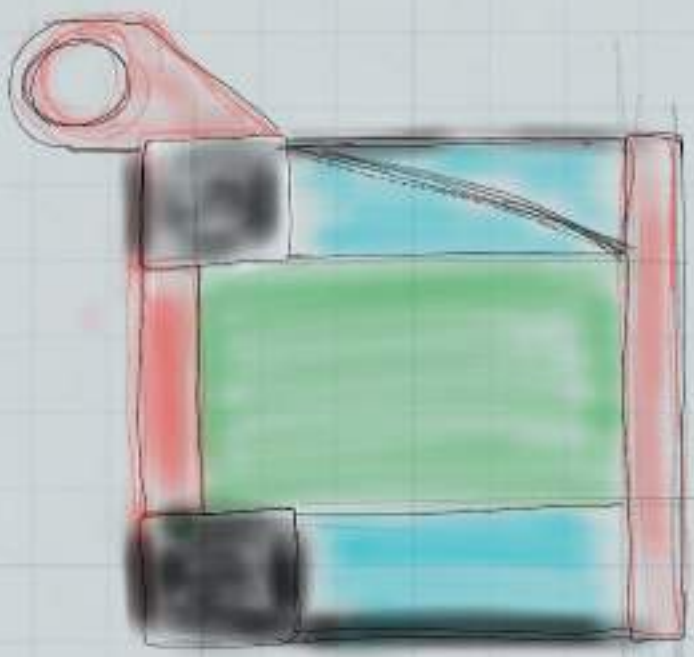

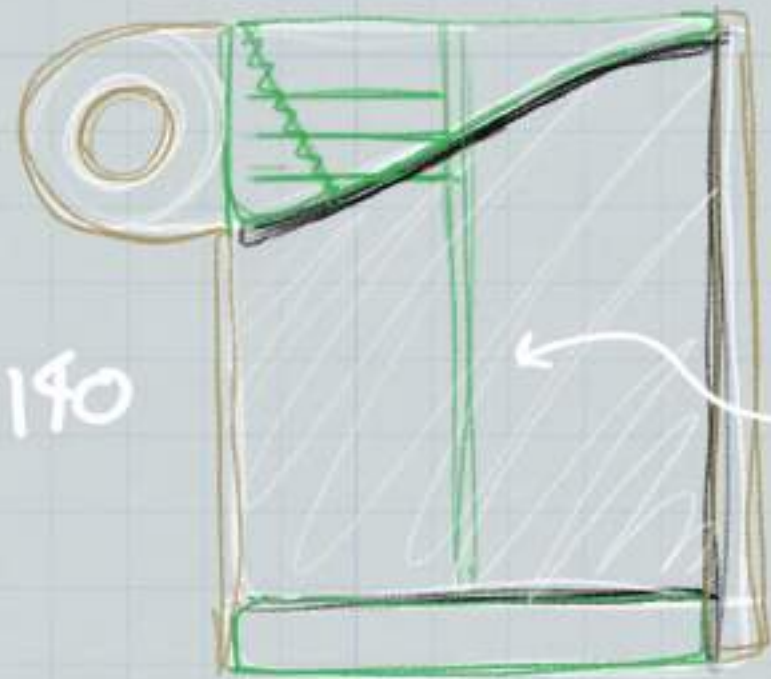
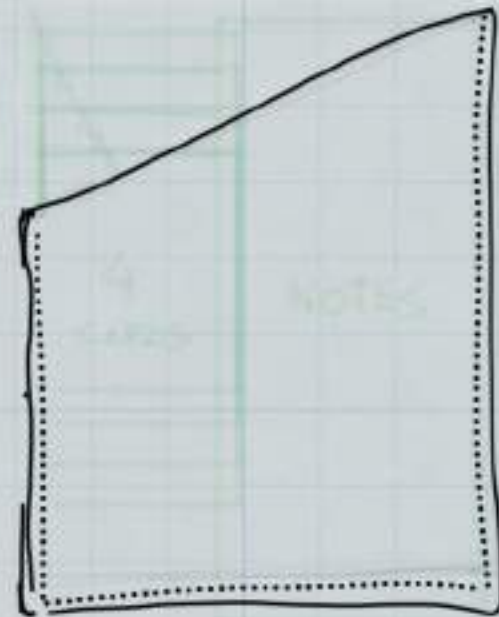
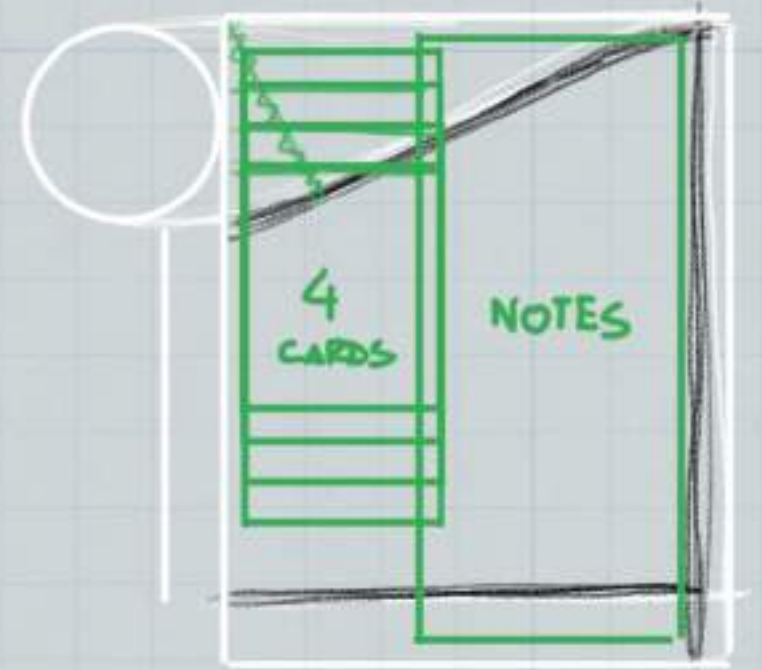
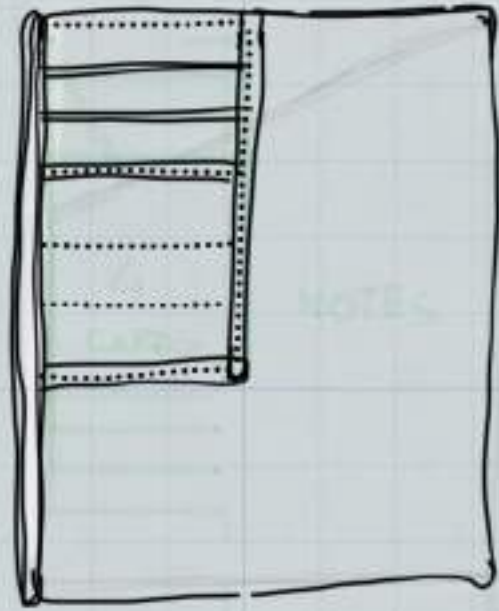
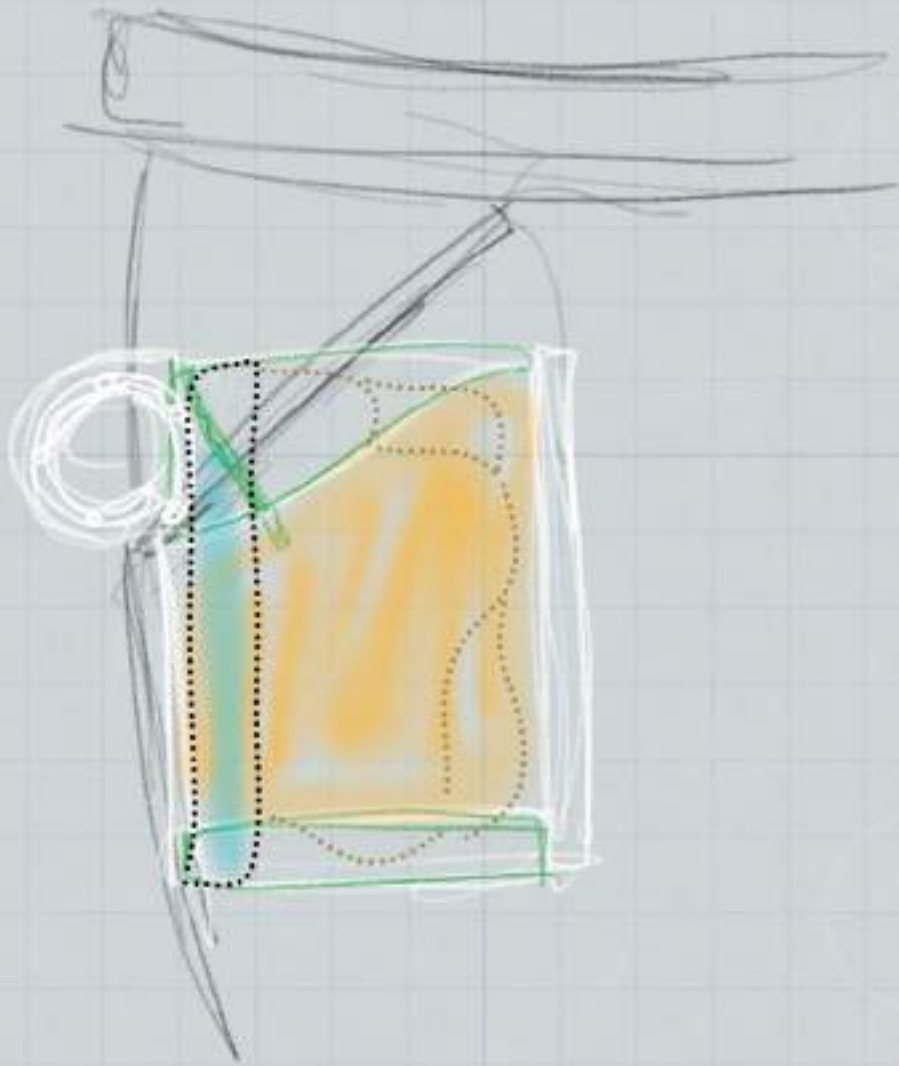

DESIGNED CLOTH

140

110

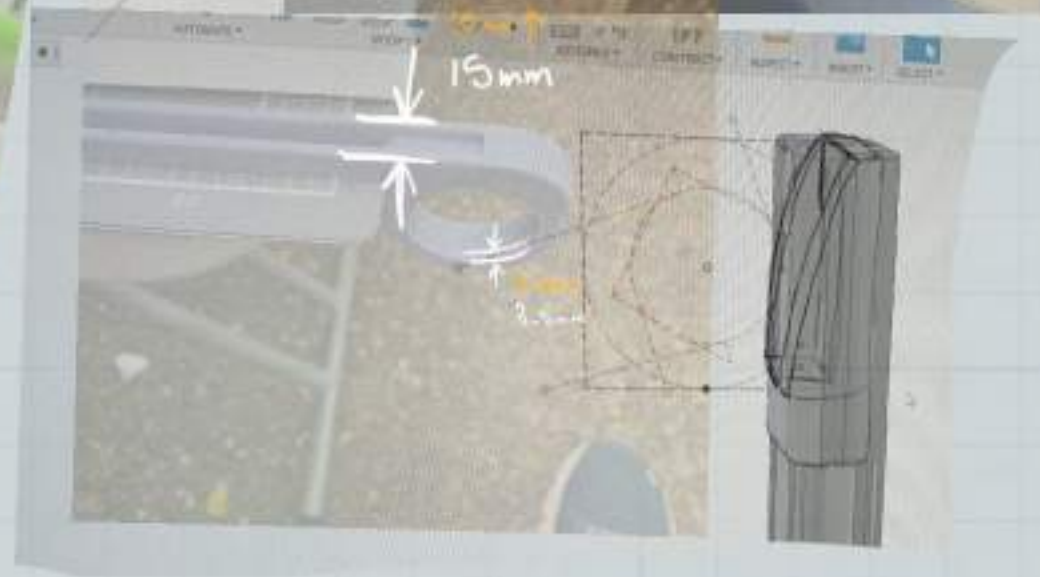
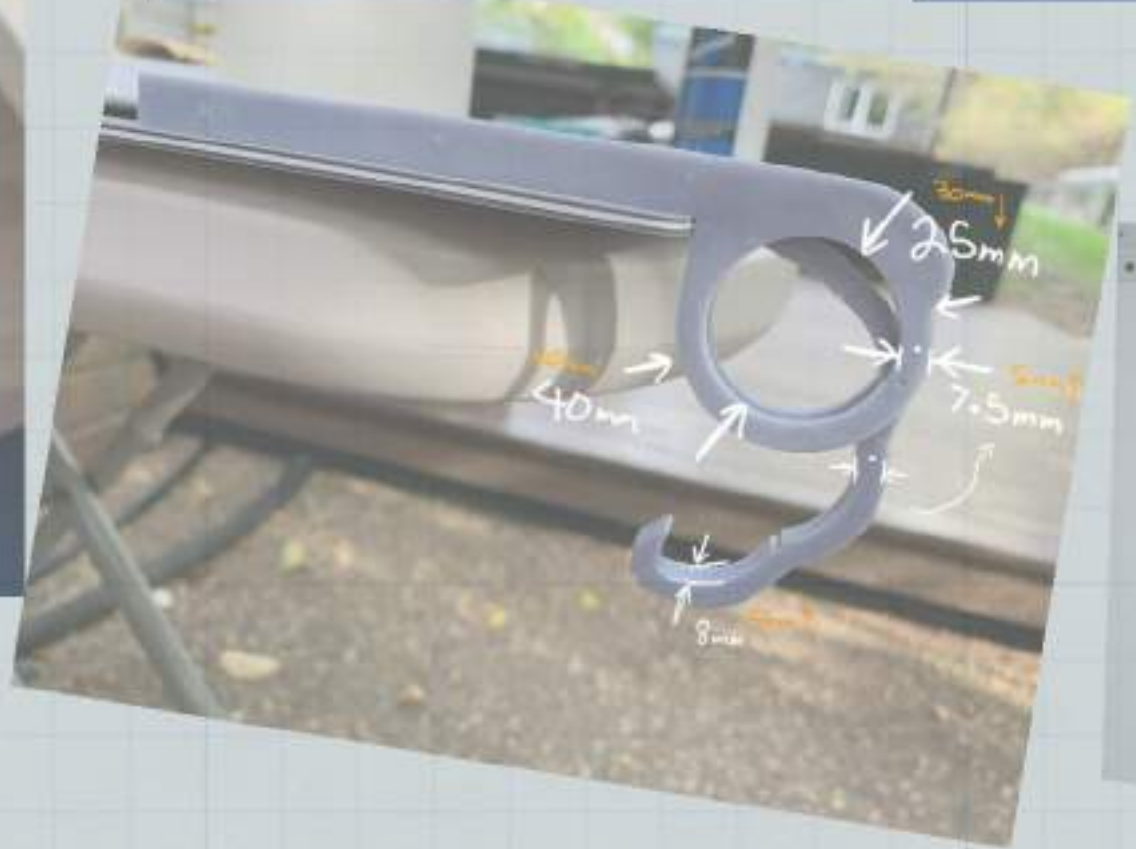
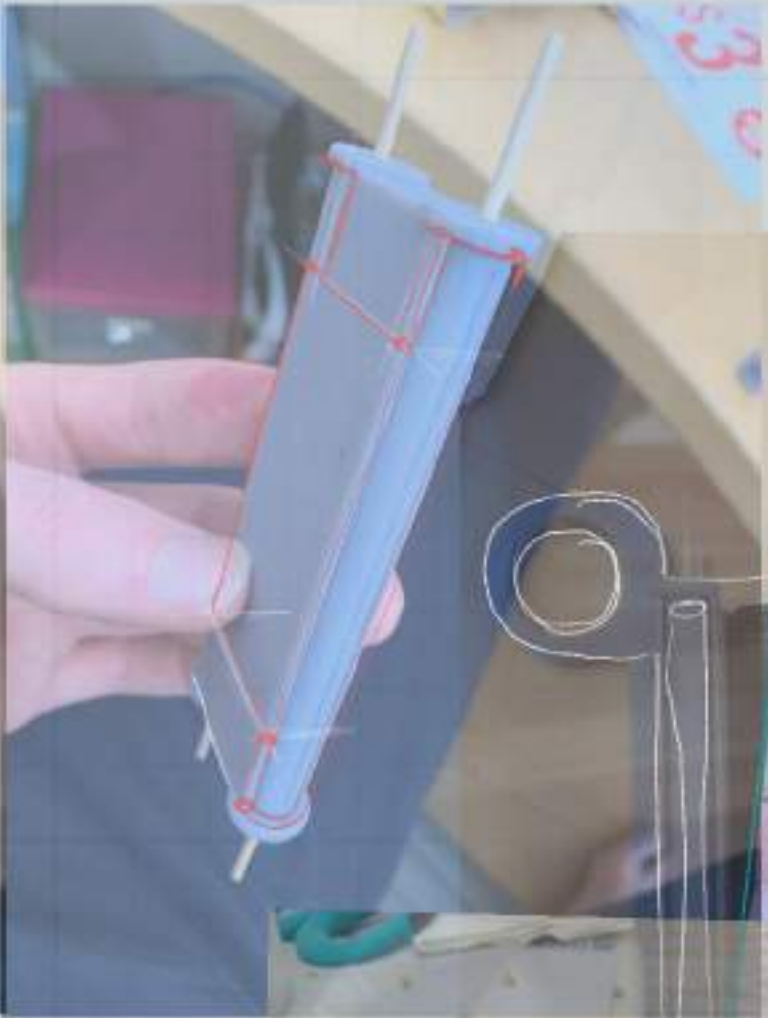
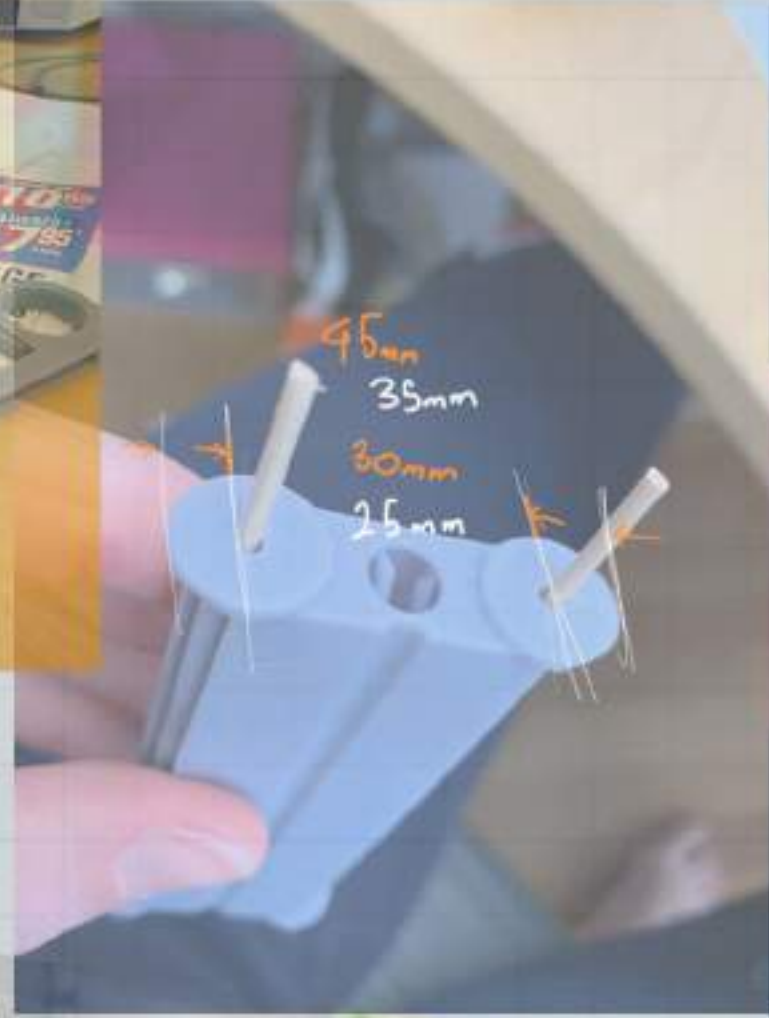

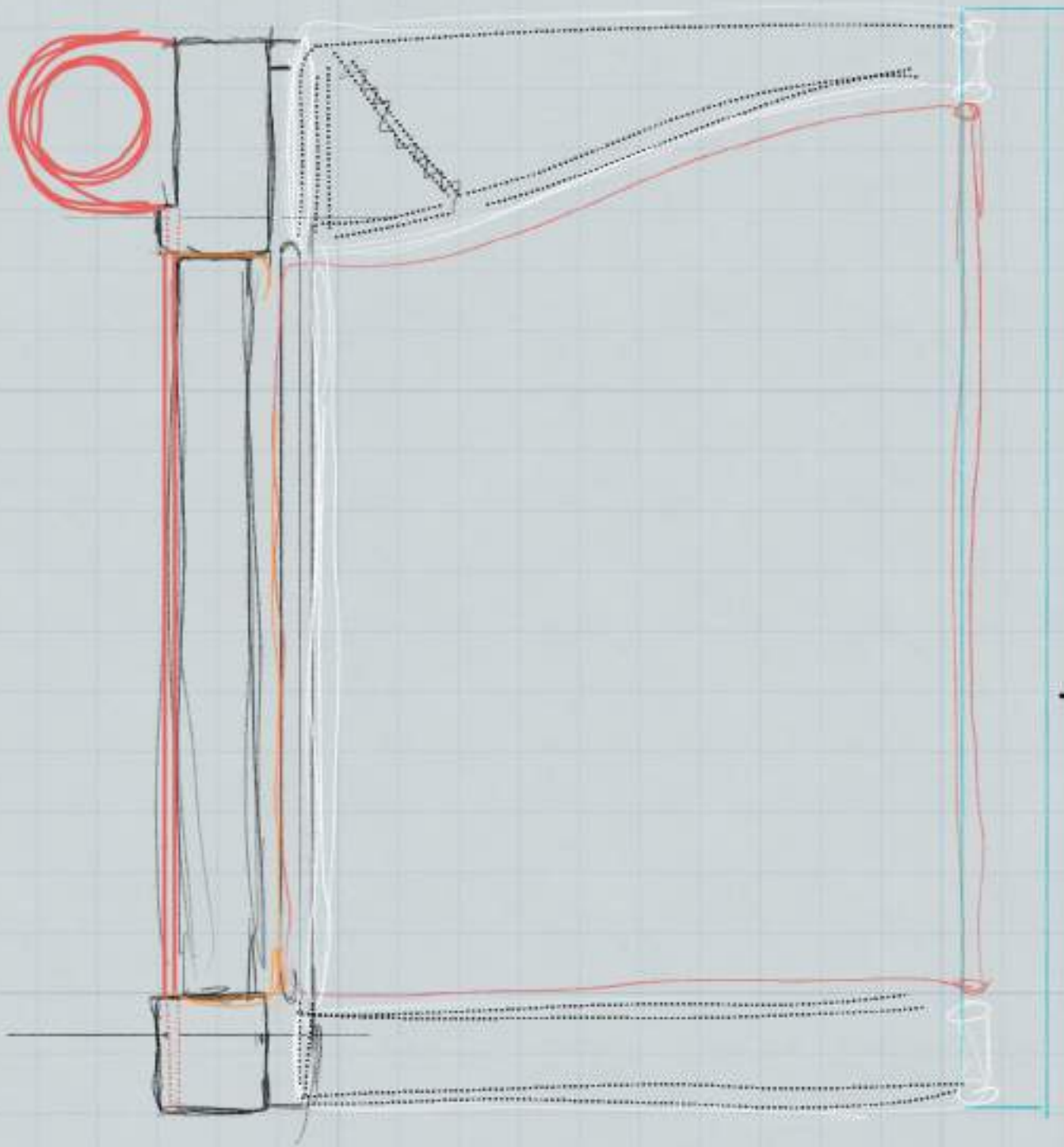

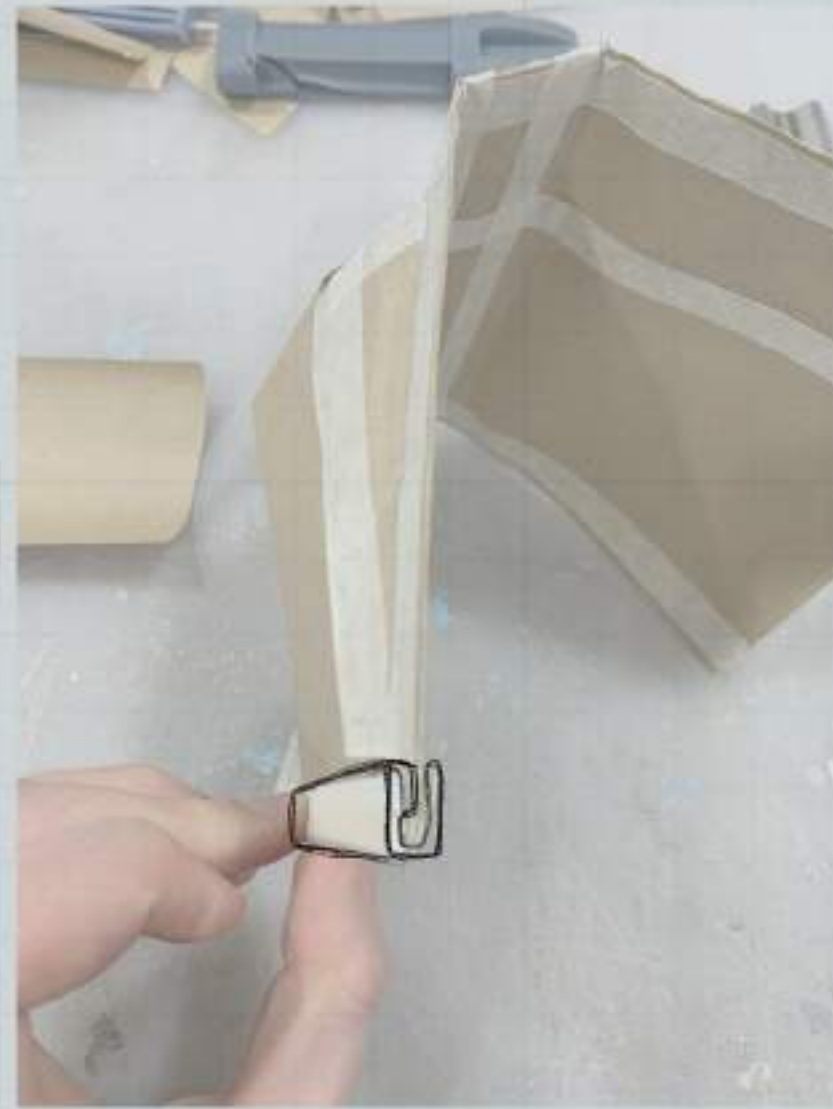
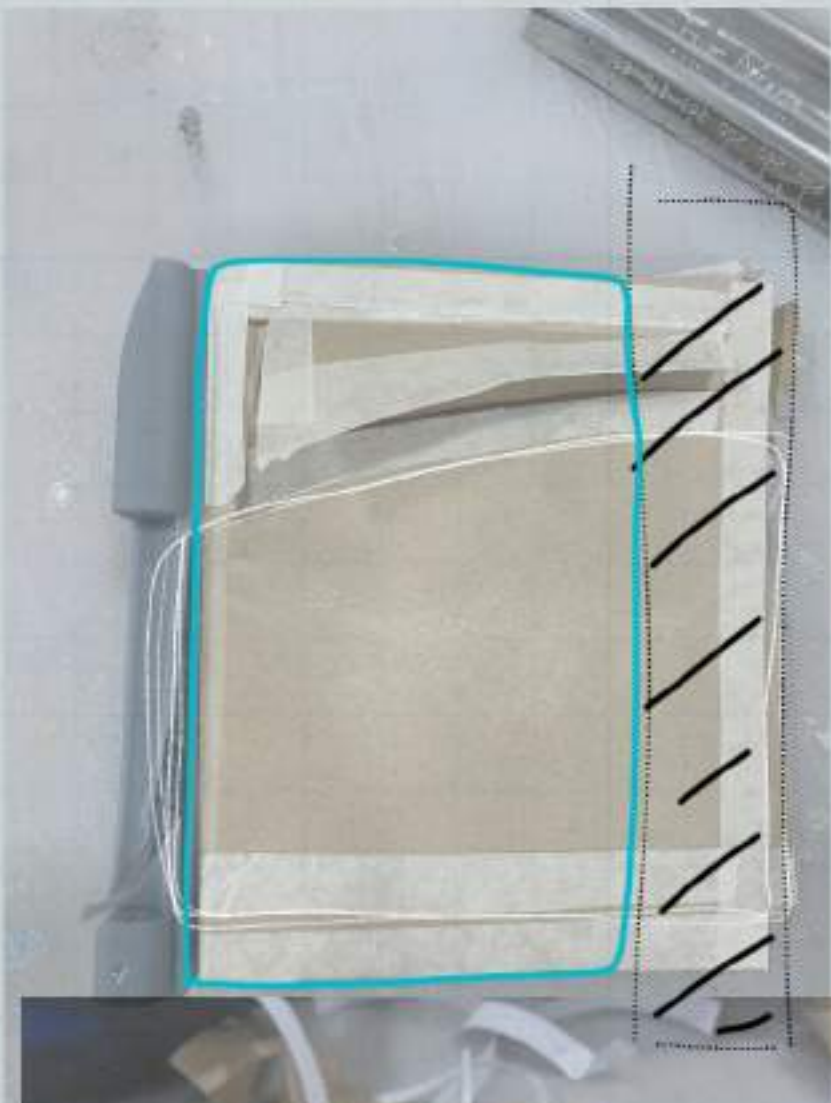

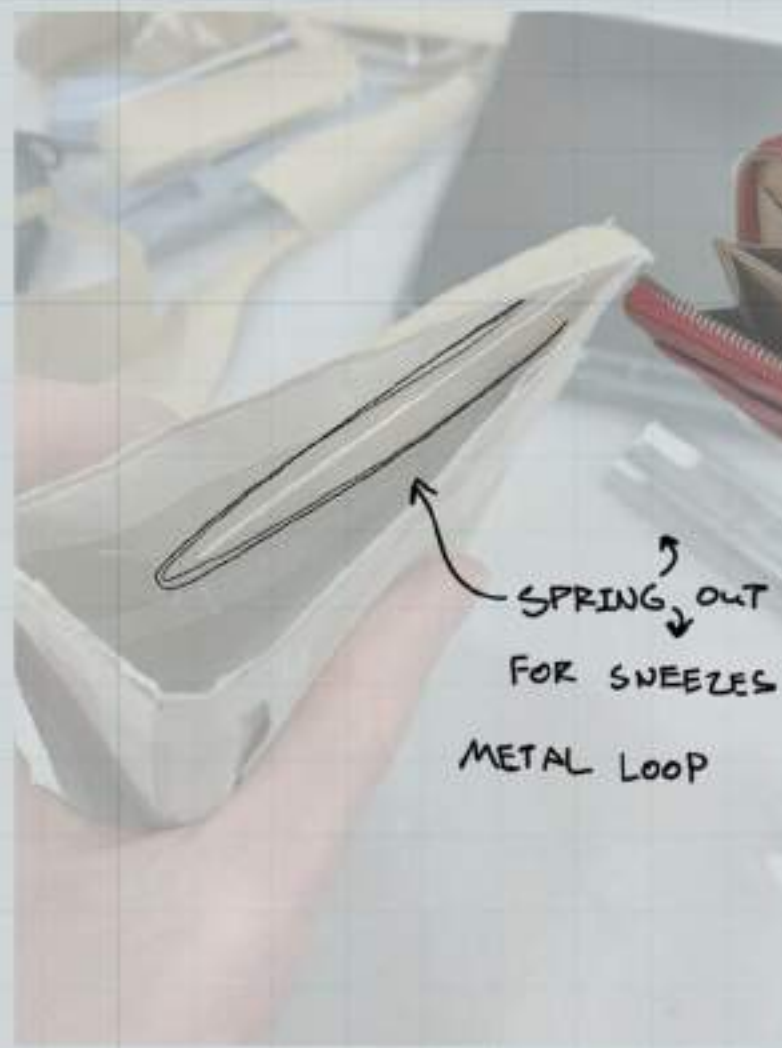
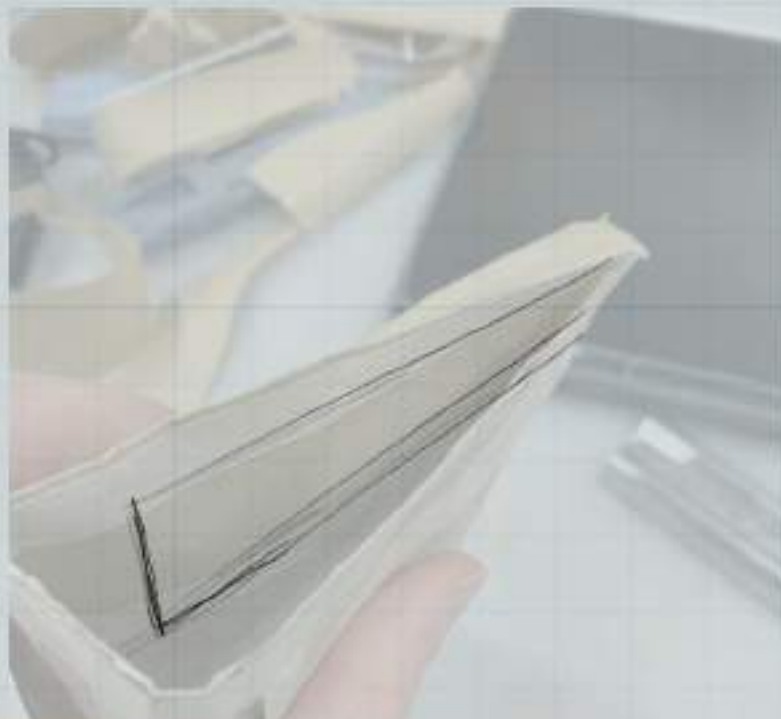

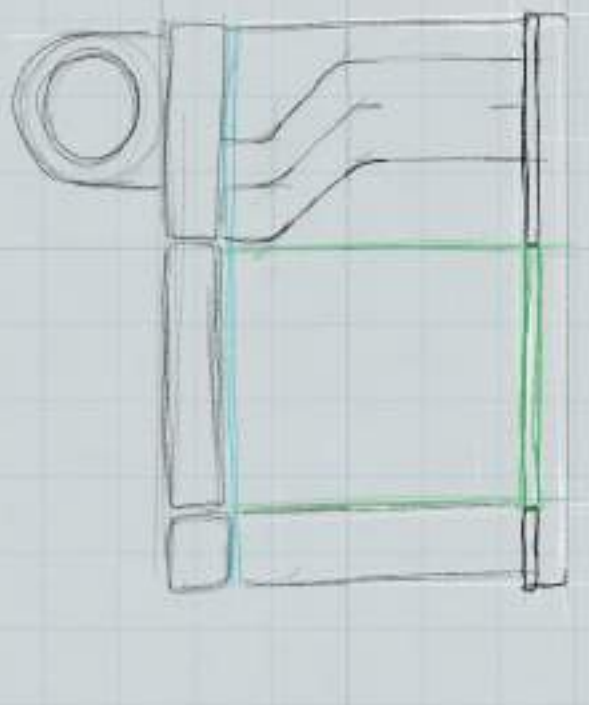
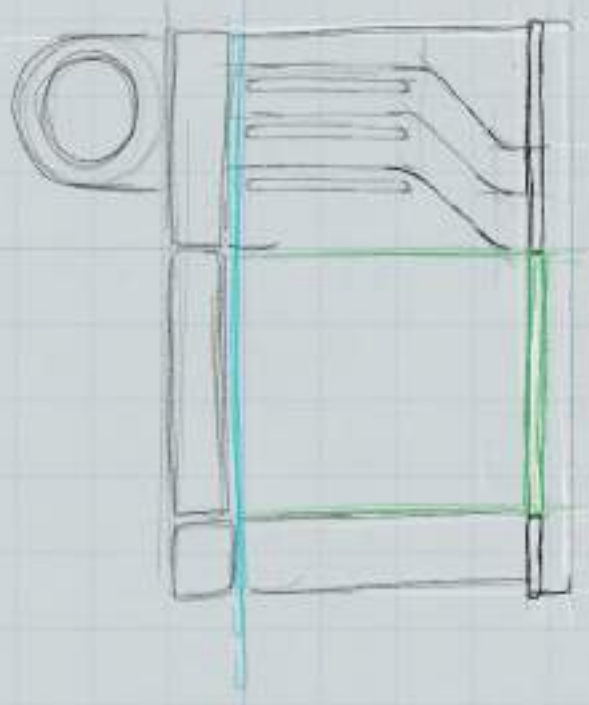
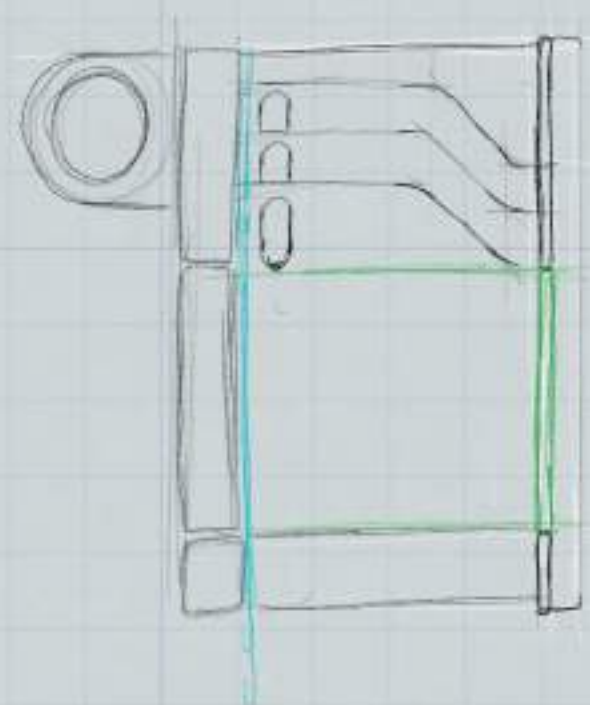
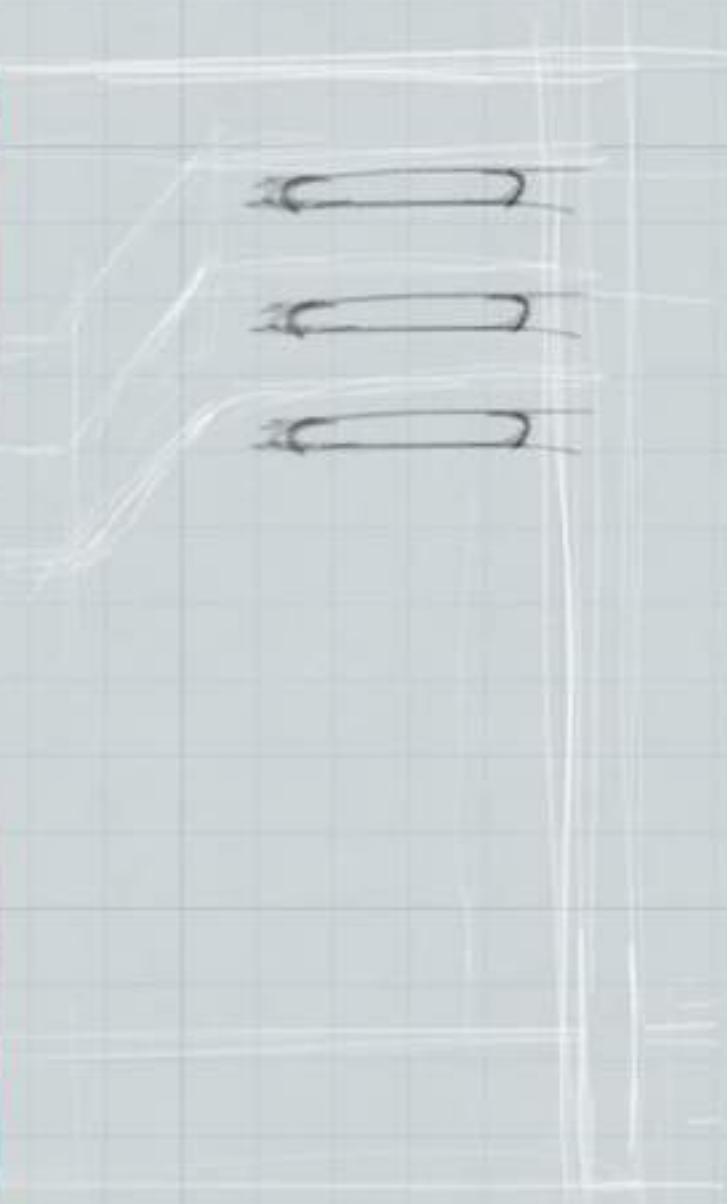
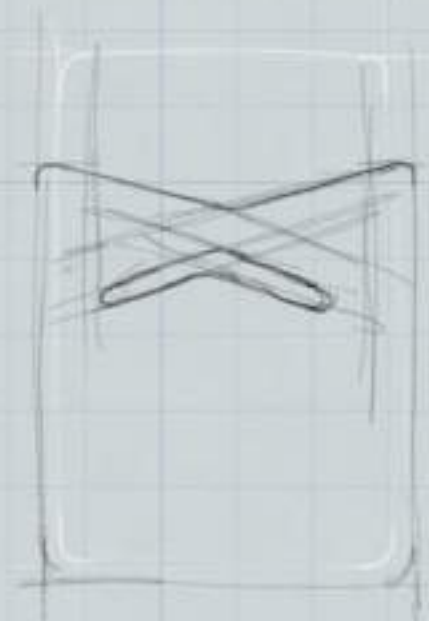

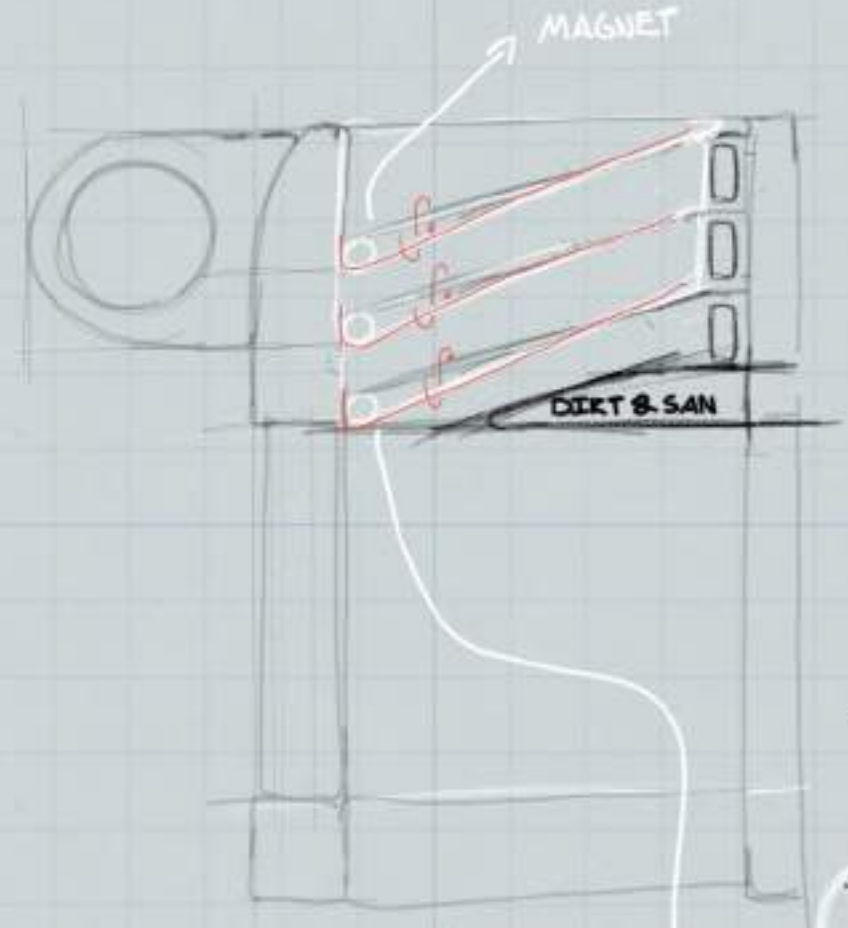
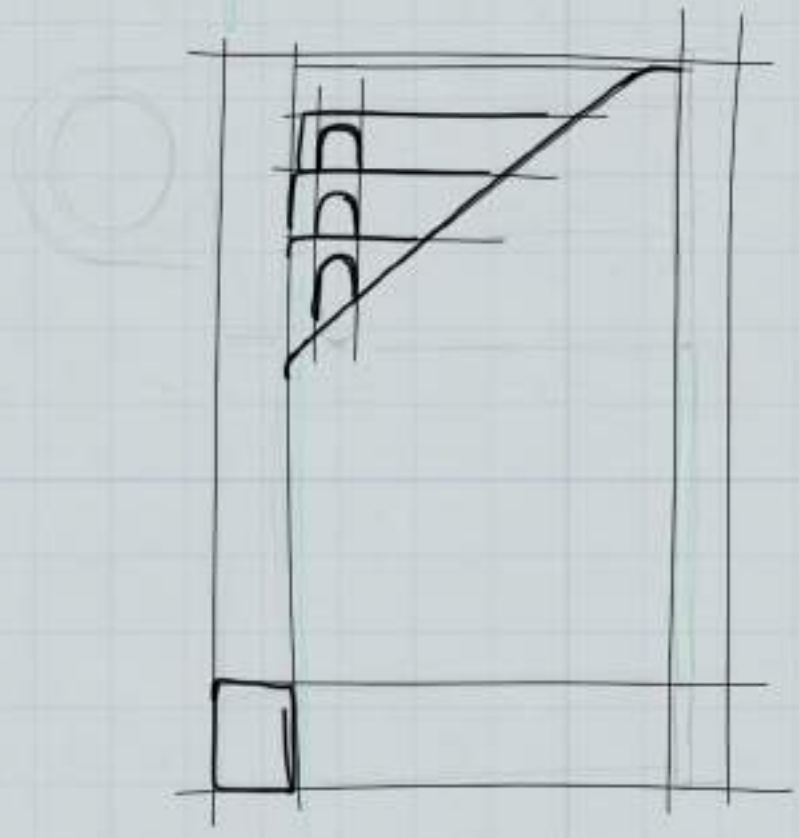
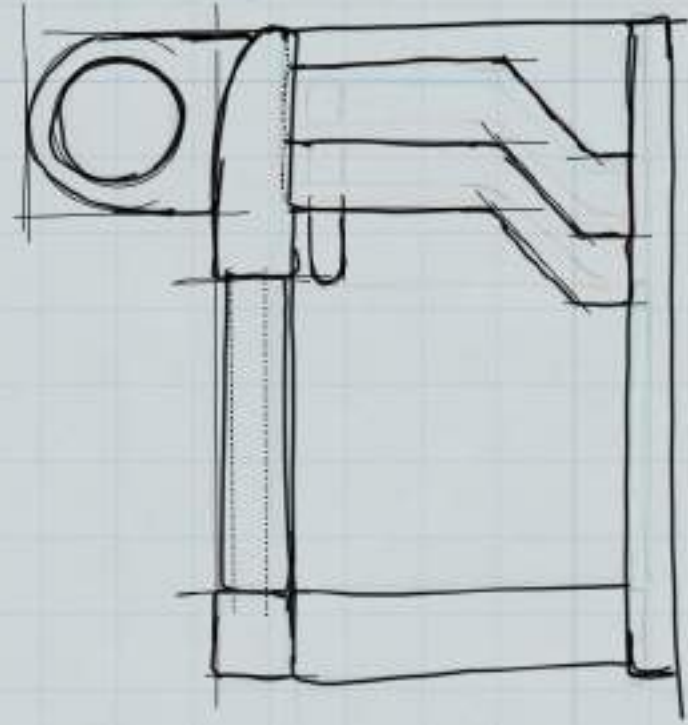
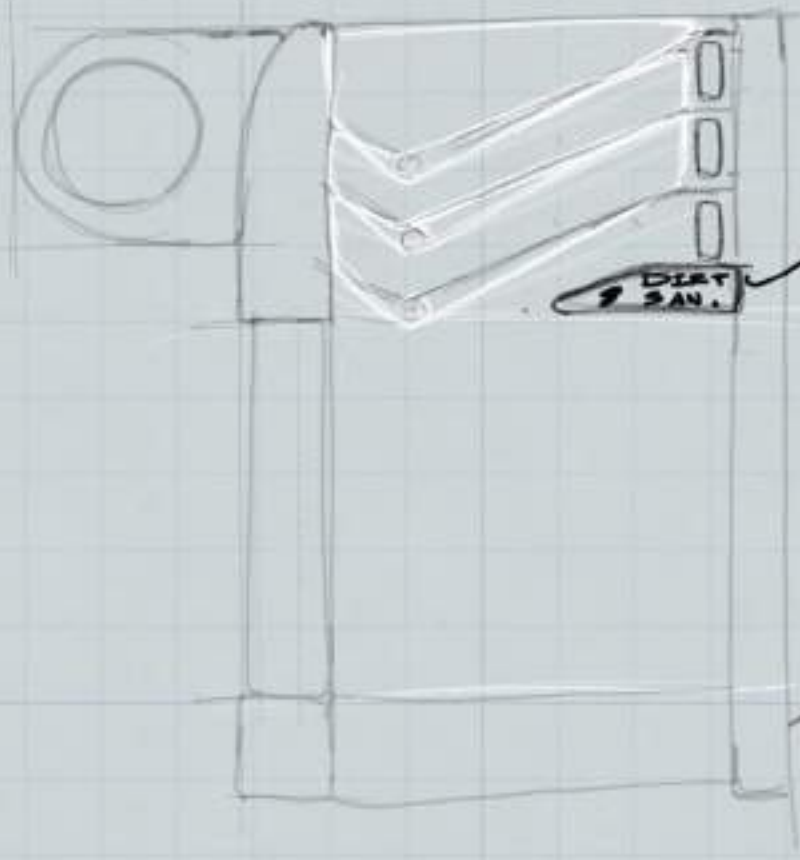
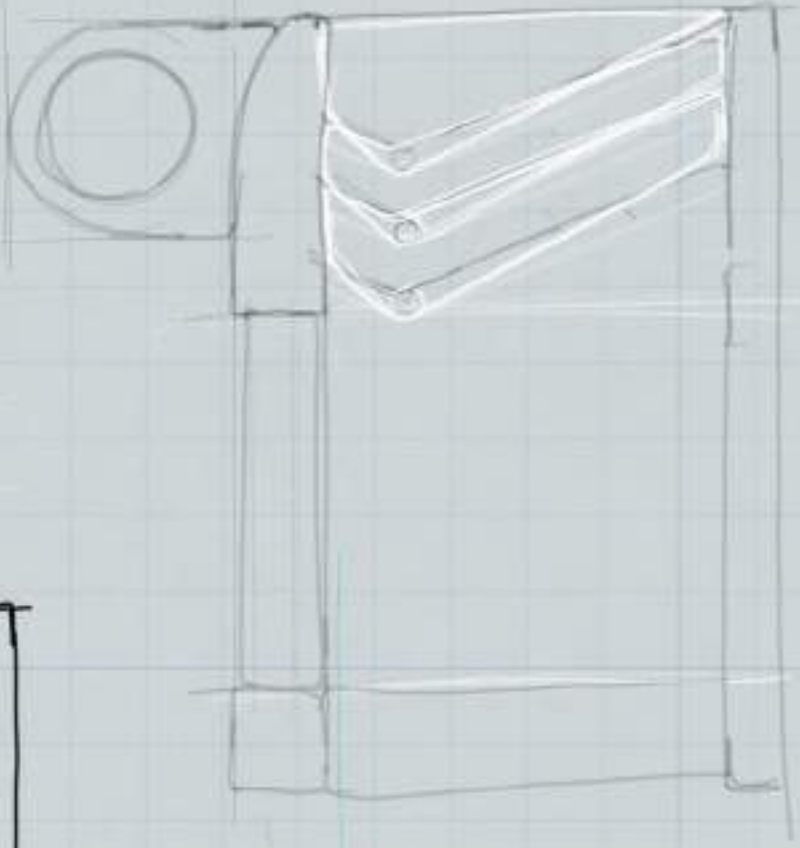
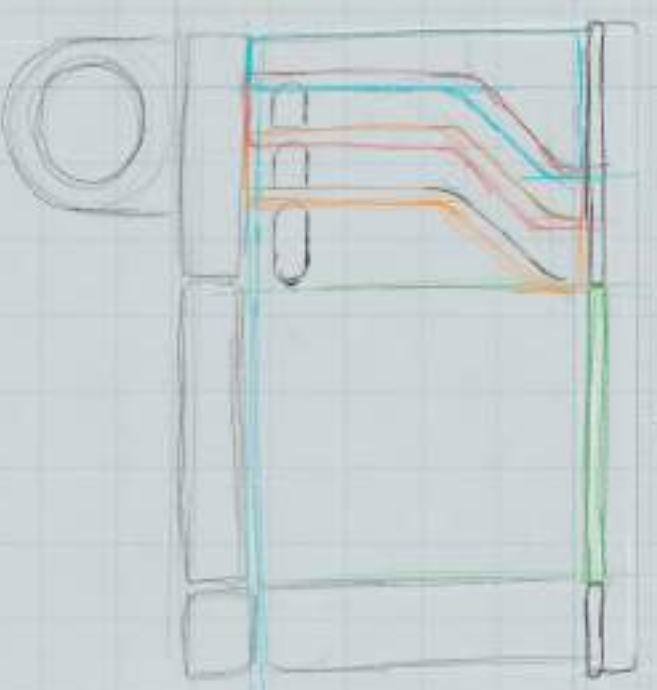

LOGO ON MAGNET

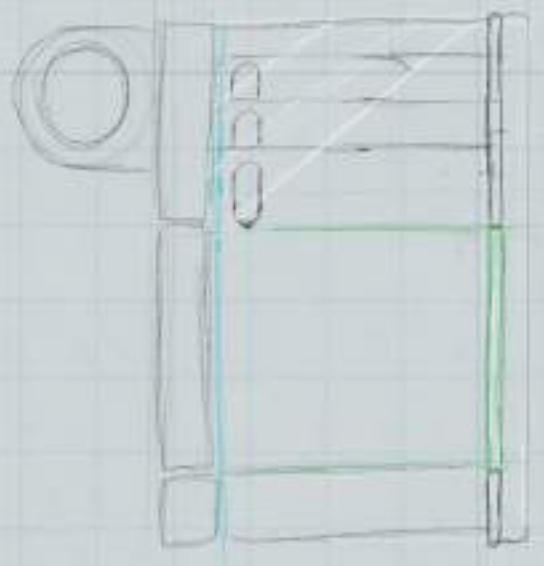

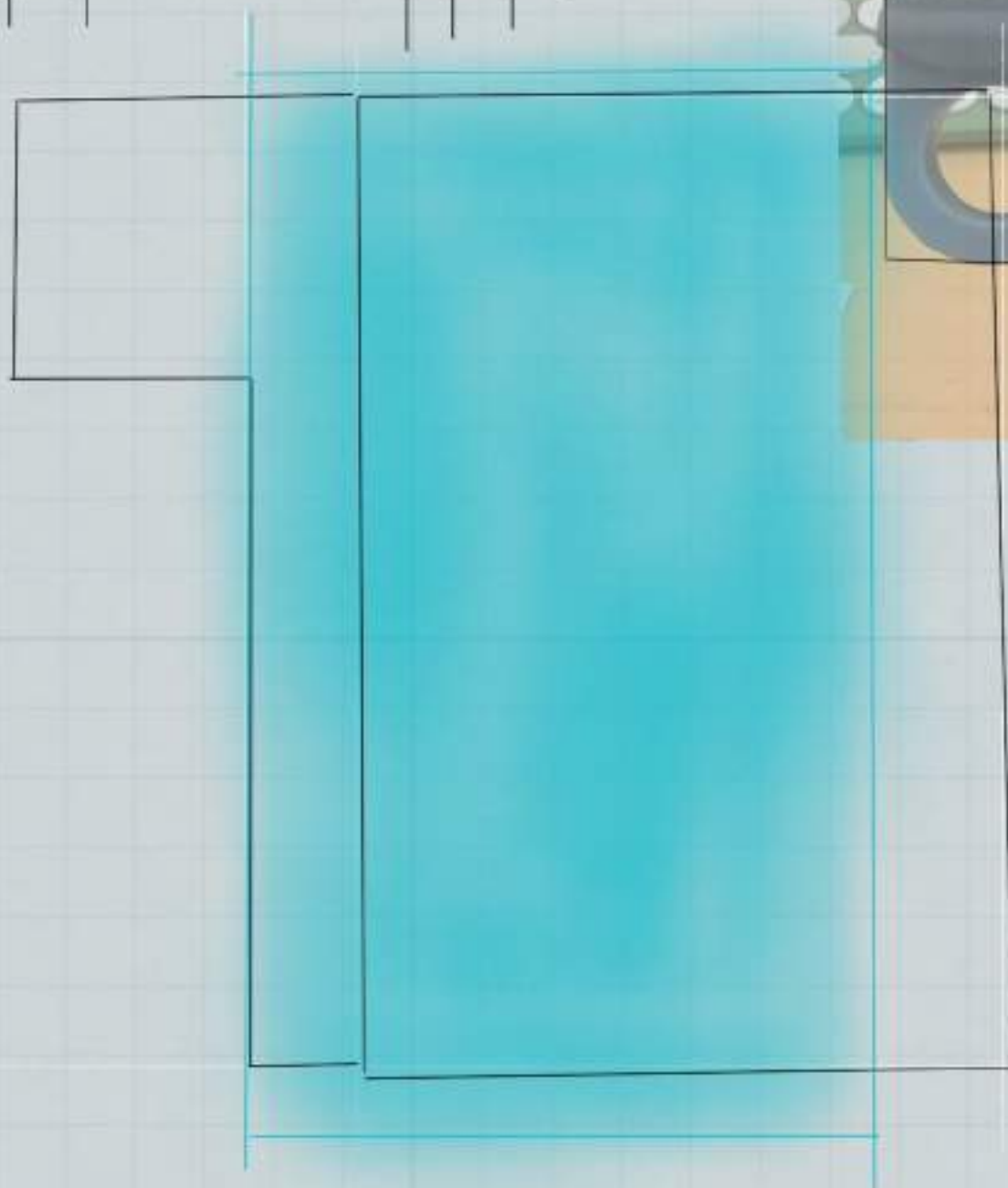
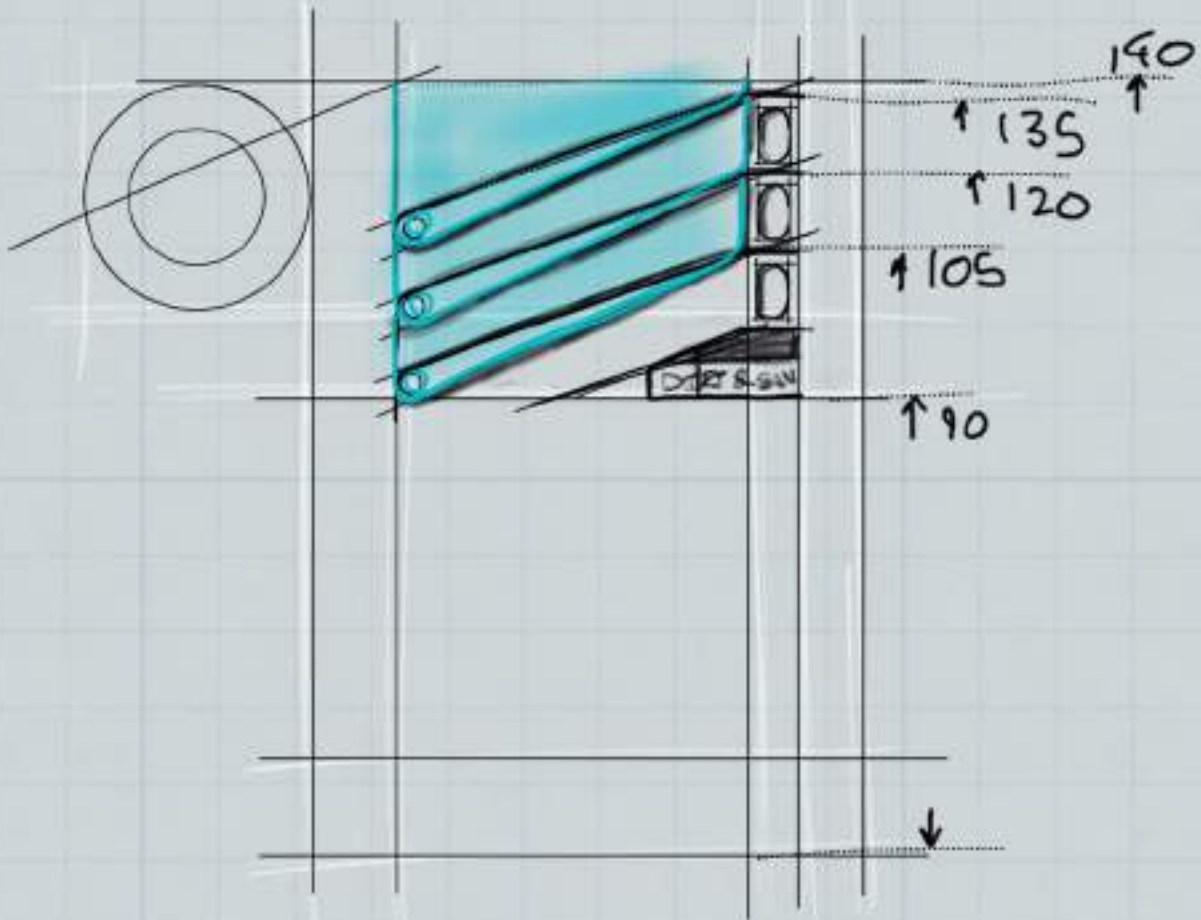
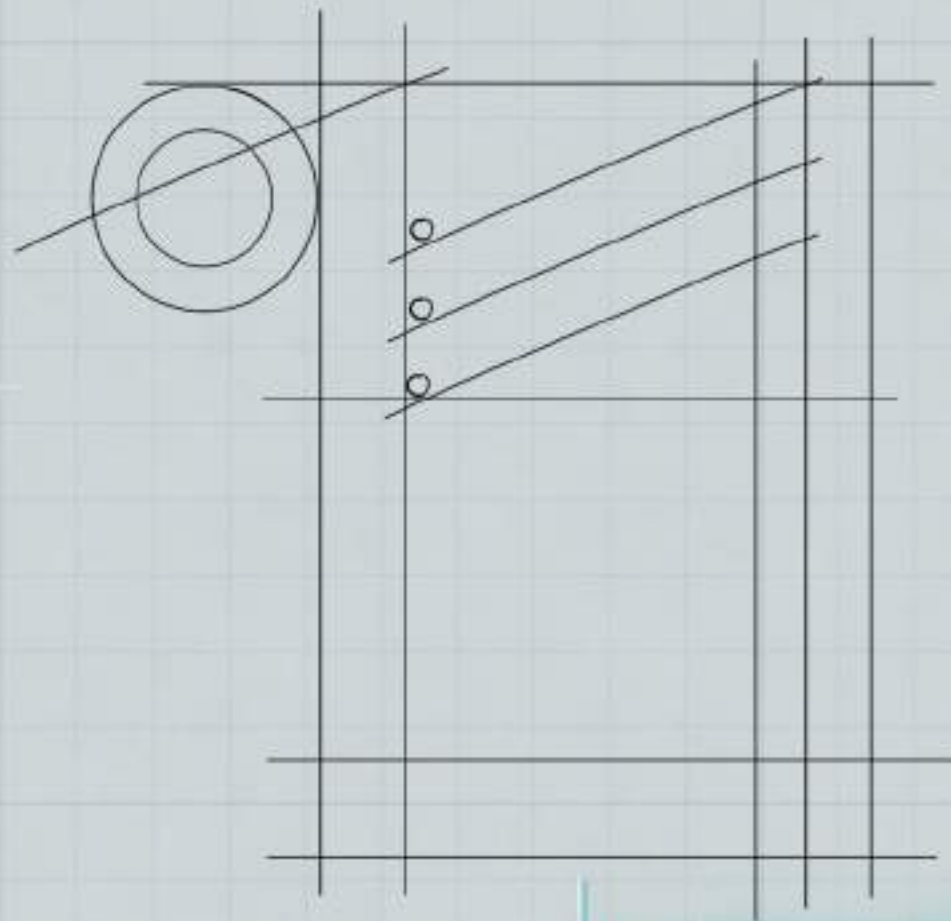
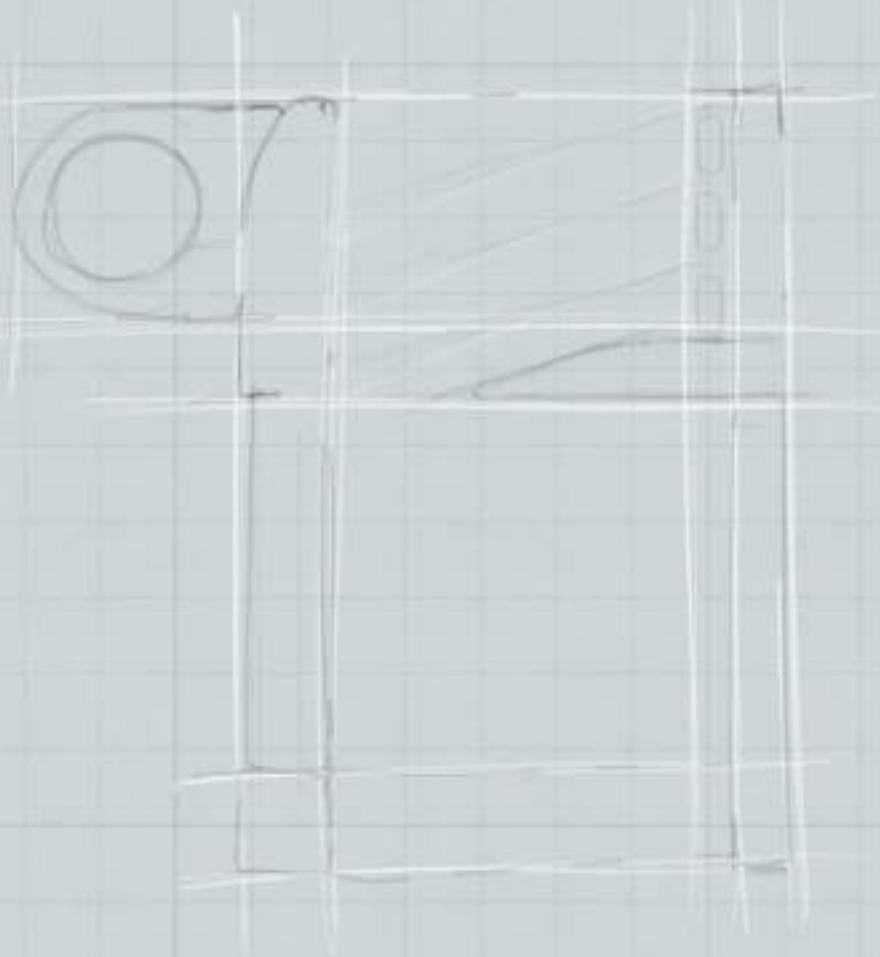

NEEDS TO BE
ON THE INSIDE

PULLING OUT
CARDS & CASH

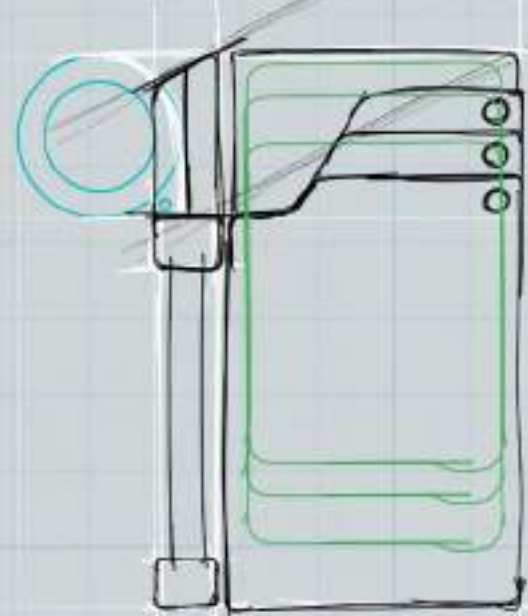

ALSO HAVE THE HANKERCHIEF
ON THE INSIDE



HAVE A SEPARATE
WALLET ON THE
INSIDE FOR
CARDS
CASH

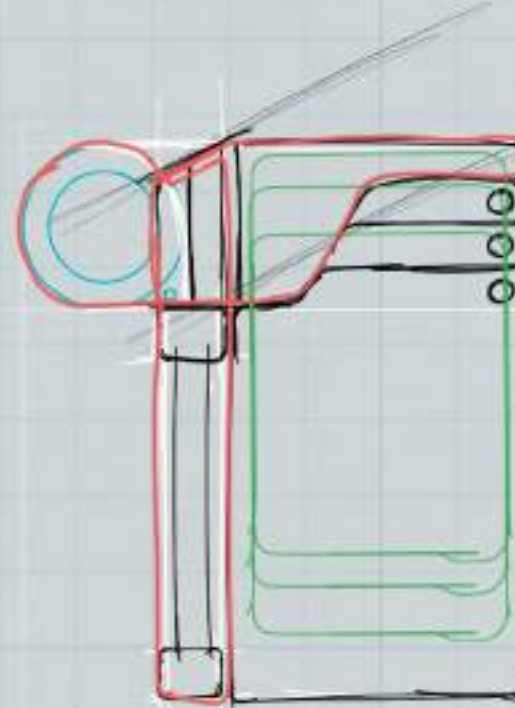
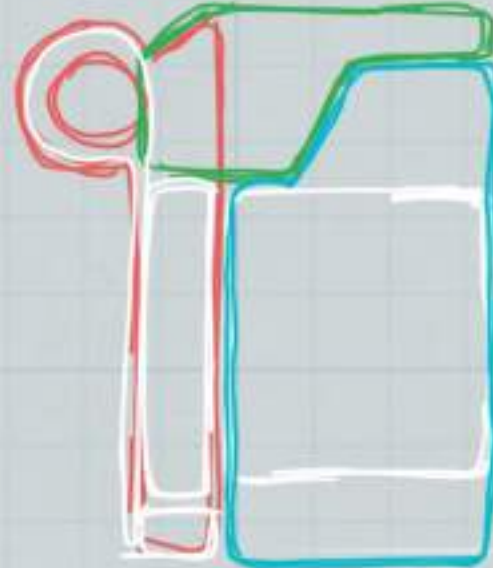

LEAVES THIS BIT
LOOSE
FOR QUICK
SNEEZE
CONTROL

HAVE CARDS OUTSIDE OF
INSIDE WALLET

HAVE AN EXTERIOR
WALLET THAT CONNECTS

MAGNET BACK
PLATE

THE OUTSIDE
WALLET NEEDS
THE MAGNET

NEED AN
INCH BETWEEN

MAGNETS CLOSE
UP

CLICKS INTO
INSIDE OF WALLET

CARDS &
MAGNET
PROXIMITY

THIS THE
WAY TO GO

MAGNETS NEEDS TO
BE AN INCH AWAY
FROM MAGNETS

FIT CASH
BEHIND TOO

TISSUE
PACKET

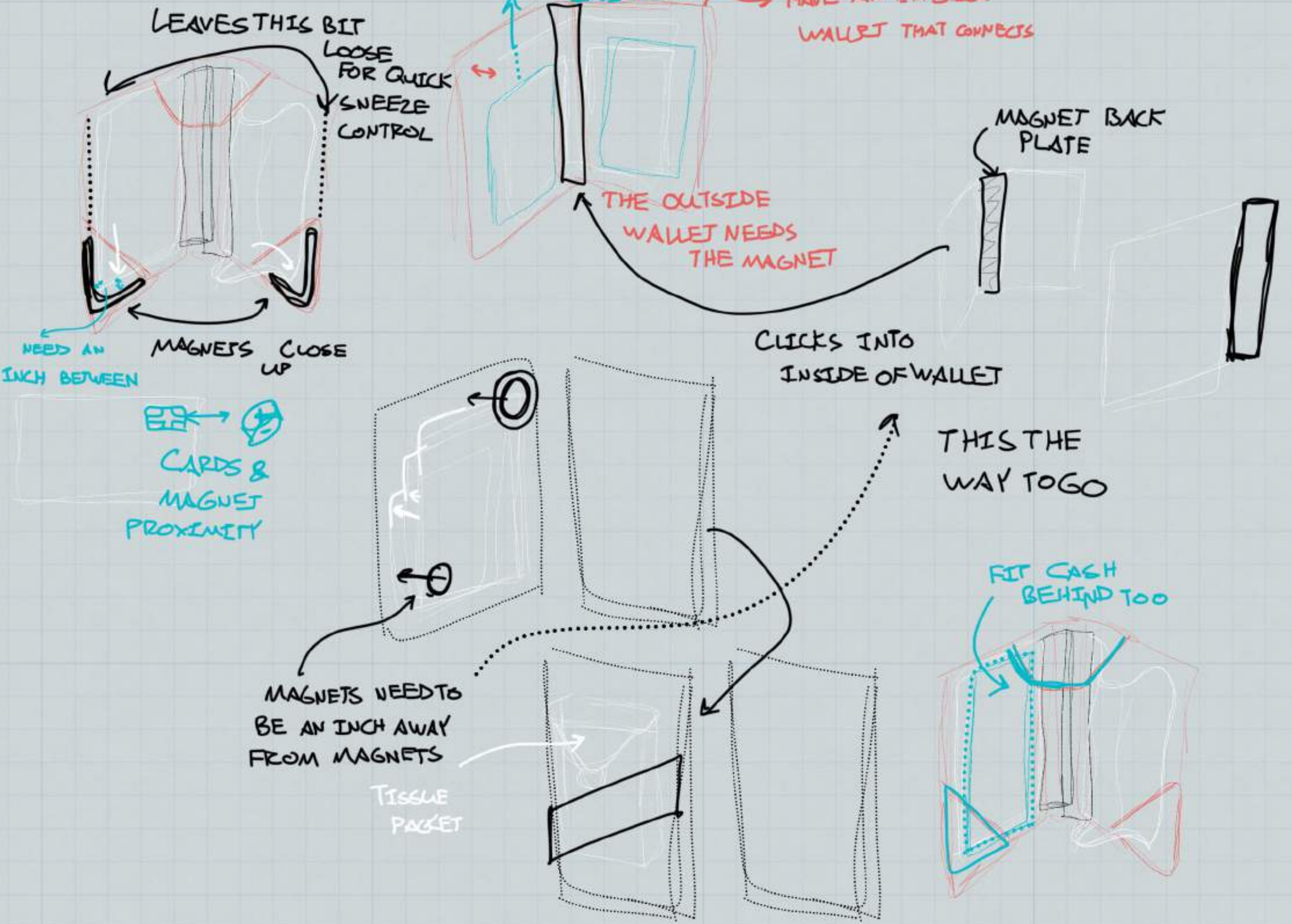

1



2



3

SANITIZER

CLEAN

LEATHER

METAL

BAG

WATER

HAND

COWBOY

PHONE CASE

SWISS ARMY KNIFE

RIDGE WALLET

GRIP 6

KIBISSIS

POUCH

KNAPSACK

LAMB SKIN

HIDE

LEATHER

FABRIC

PROVISIONS

SURVIVE A DAY OR WEEK

HIP

WORN

POCKET

PURSE

CURRENCY

BI-FOLD

MAGNETIC

DIRTY MONEY

DIRT & SAN.

FILTHY RICH

CLEAN LIVING

STREET LEGAL

EASY MONEY

LONGWALLET

POCKET SNEEZER

PORTABLE

CLEAN

WALLETS LEATHER

BIFOLD THE

CARRIER

CL
CLEAN
LEATHER
— 5 —

L

L

L

CL
CLEAN
LEATHER

CL
CLEAN
LEATHER
— 5 —

CL
CLEAN
LEATHER

CL
CLEAN
LEATHER
— 5 —

CL
CLEAN
LEATHER
— 5 —

C

L

L

CL

C

C

l

C

CL

C

C

L

L

L

L

C

L

C

L

L

L

L

CL

CL
CLEAN
LEATHER
— ◊ —



CLEAN
LEATHER

CL
CLEAN
LEATHER
— ◊ —

CL
CLEAN
LEATHER
— ◊ —

CL
CLEAN
LEATHER
— ◊ —

*Clean
Leather*

*Clean
Leather*

CL
*Clean
Leather*
— ◊ —

*Clean
Leather*

~~*Clean
Leather*~~

~~*Clean
Leather*~~

CL
— ◊ —
*Clean
Leather*

*Clean
Leather*

CL

*Clean
Leather*

CLEAN
LEATHER

CL

CL
— ◊ —

CL
— ◊ —
*Clean
Leather*

5-to-6-inch iPhone models		
iPhone model	Display size / type	Dimensions
iPhone 13 Mini	5.4-inch OLED	131.5 x 64.2 x 7.65mm / 140g
iPhone 12 Mini	5.4-inch OLED	131.5 x 64.2 x 7.4mm / 133g
iPhone 11 Pro	5.8-inch OLED	144 x 71.4 x 8.1mm / 188g
iPhone XS	5.8-inch OLED	143.6 x 70.9 x 7.7mm / 177g
iPhone X	5.8-inch OLED	143.6 x 70.9 x 7.7mm / 174g
iPhone 8 Plus	5.8-inch LCD	158.4 x 78.1 x 7.5mm / 202g
iPhone 7 Plus	5.5-inch LCD	158.2 x 77.9 x 7.3mm / 188g
iPhone 6S Plus	5.5-inch LCD	158.2 x 77.9 x 7.3mm / 192g
iPhone 6 Plus	5.5-inch LCD	158.1 x 77.8 x 7.1mm / 143g

Handwritten notes: 120, 190, 2, 3, 4. A red button at the bottom says "COMPARE IPHONE DEALS".

Under 5-inch iPhone models		
iPhone model	Display size / type	Dimensions
iPhone SE (2022)	4.7-inch LCD	138.4 x 67.3 x 7.3mm / 144g
iPhone SE (2020)	4.7-inch LCD	138.4 x 67.3 x 7.3mm / 148g
iPhone 8	4.7-inch LCD	138.4 x 67.3 x 7.3mm / 148g
iPhone 7	4.7-inch LCD	138.3 x 67.3 x 7.1mm / 138g
iPhone 6S	4.7-inch LCD	138.3 x 67.3 x 7.1mm / 143g
iPhone 6	4.7-inch LCD	138.1 x 67 x 6.9mm / 129g
iPhone SE (2016)	4.0-inch LCD	123.8 x 58.6 x 7.6mm / 113g
iPhone 5S	4.0-inch LCD	123.8 x 58.6 x 7.6mm / 112g
iPhone 5C	4.0-inch LCD	124.4 x 59.2 x 9mm / 132g
iPhone 5	4.0-inch LCD	123.8 x 58.6 x 7.6mm / 112g
iPhone 4S	3.5-inch LCD	115.2 x 58.6 x 9.3mm / 140g
iPhone 4	3.5-inch LCD	115.2 x 58.6 x 9.3mm / 137g
iPhone 3GS	3.5-inch TFT	115.5 x 62.1 x 12.3mm / 135g
iPhone 3G	3.5-inch TFT	115.5 x 62.1 x 12.3mm / 135g
iPhone (original)	3.5-inch TFT	115 x 61 x 11.6mm / 135g

Handwritten notes: 120, 190, 158, 128, 190 CURRENT HEIGHT.

Over 6-inch iPhone models		
iPhone model	Display size / type	Dimensions / Weight
iPhone 14 Pro Max	6.7-inch OLED	160.7 x 77.6 x 7.9mm / 240g
iPhone 14 Plus	6.7-inch OLED	160.8 x 78.1 x 7.8mm / 203g
iPhone 14 Pro	6.1-inch OLED	147.5 x 71.5 x 7.9mm / 206g
iPhone 14	6.1-inch OLED	146.7 x 71.5 x 7.8mm / 172g
iPhone 13 Pro Max	6.7-inch OLED	160.8 x 78.1 x 7.65mm / 238g
iPhone 13 Pro	6.1-inch OLED	146.7 x 71.5 x 7.65mm / 203g
iPhone 13	6.1-inch OLED	146.7 x 71.5 x 7.65mm / 173g
iPhone 12 Pro Max	6.7-inch OLED	160.8 x 78.1 x 7.4mm / 225g
iPhone 12 Pro	6.1-inch OLED	146.7 x 71.5 x 7.4mm / 187g
iPhone 12	6.1-inch OLED	146.7 x 71.5 x 7.4mm / 162g
iPhone 11 Pro Max	6.5-inch OLED	158 x 77.8 x 8.1mm / 226g
iPhone 11	6.1-inch LCD	150.9 x 75.7 x 8.3mm / 194g
iPhone XS Max	6.5-inch OLED	157.5 x 77.4 x 7.7mm / 208g
iPhone XR	6.1-inch LCD	150.9 x 75.7 x 8.3mm / 194g

Handwritten notes: 190, 150, 2, 1, 2, 4.

Handwritten notes for wallet dimensions:

- 11x 165 ↑ WALLET
- 9x 150 ↑ WALLET
- 9x 190 ↑ WALLET

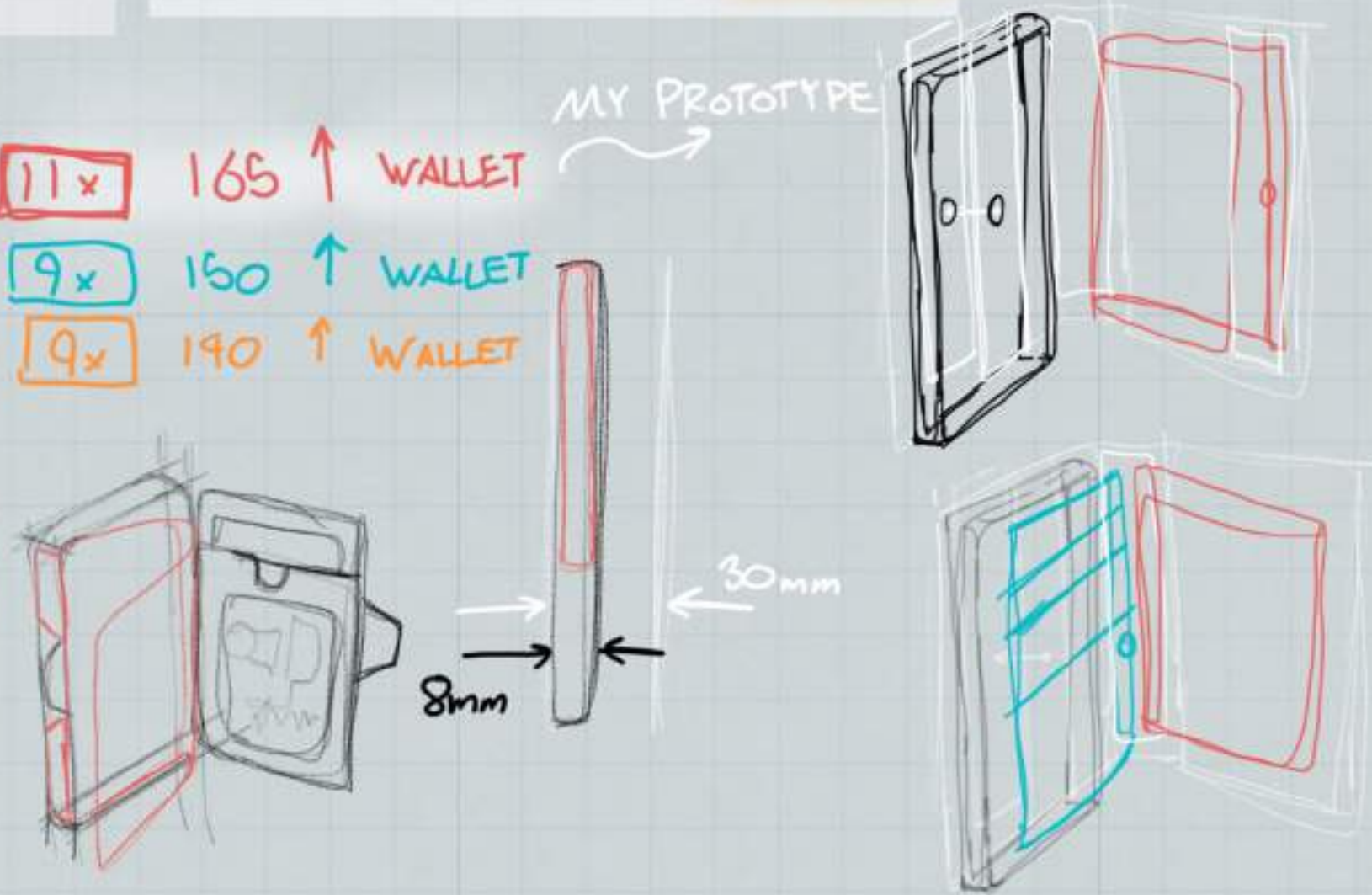

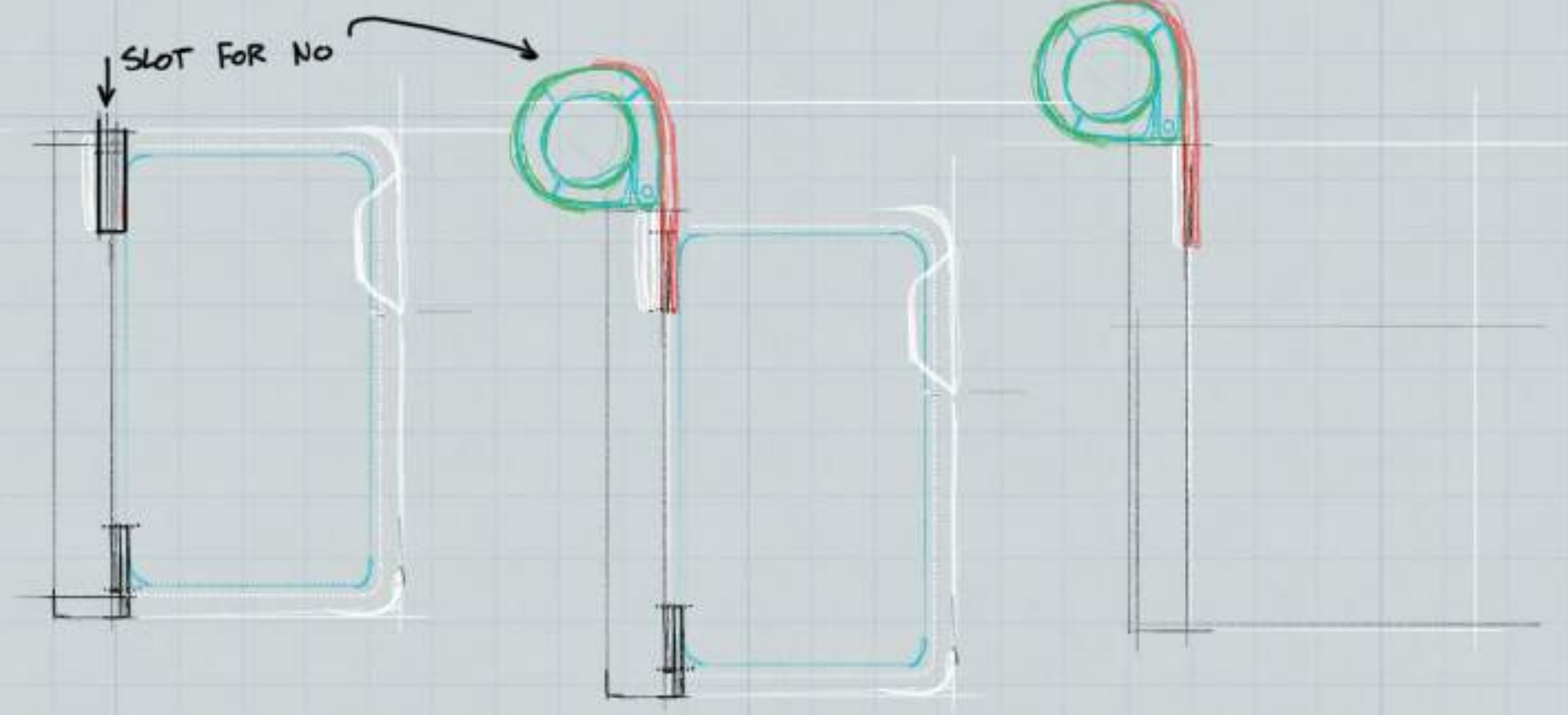
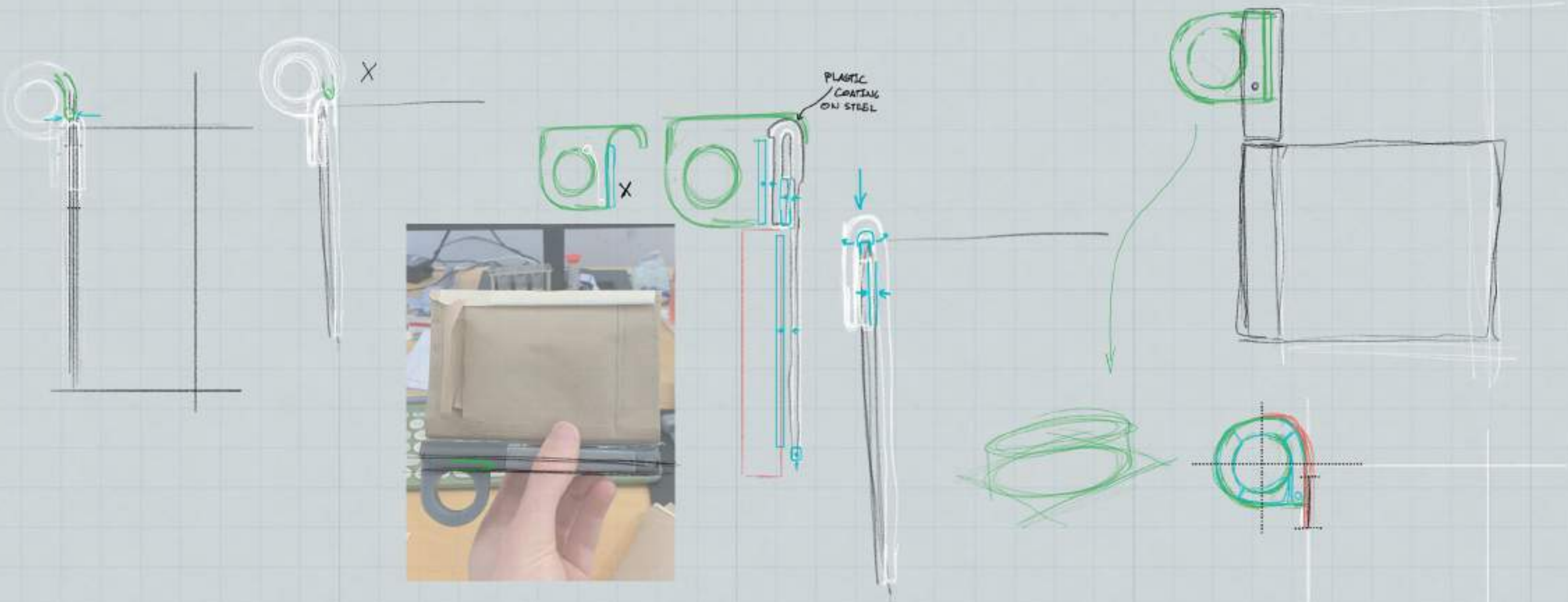

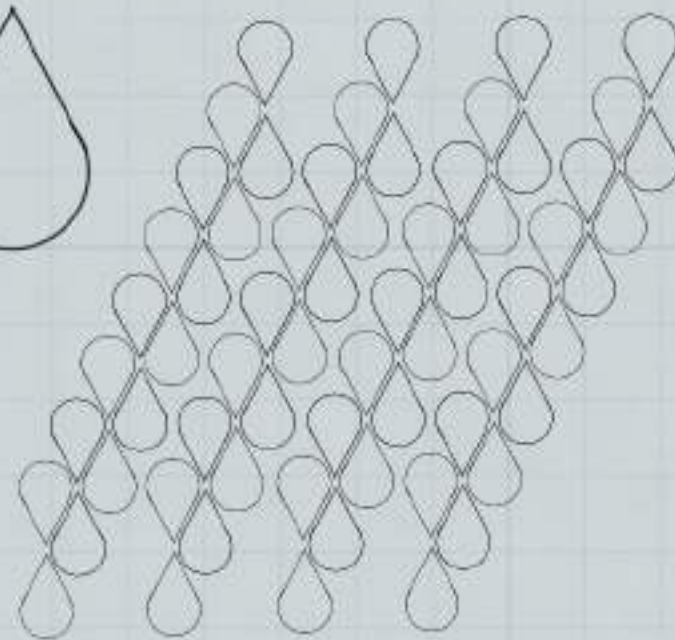
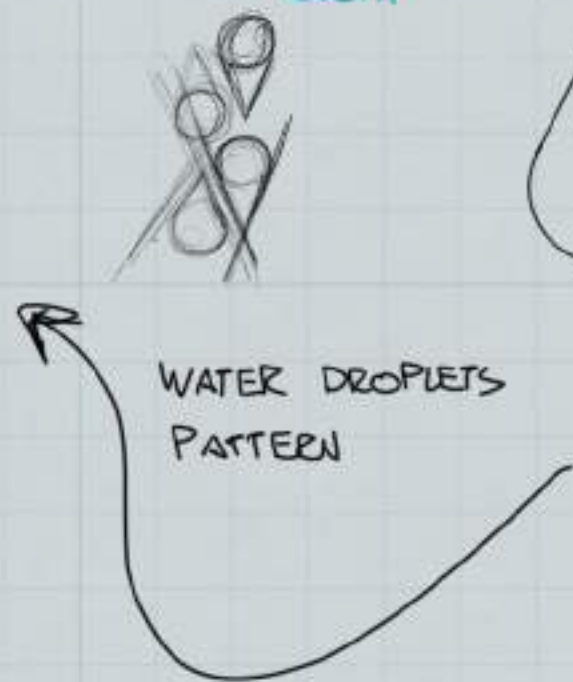
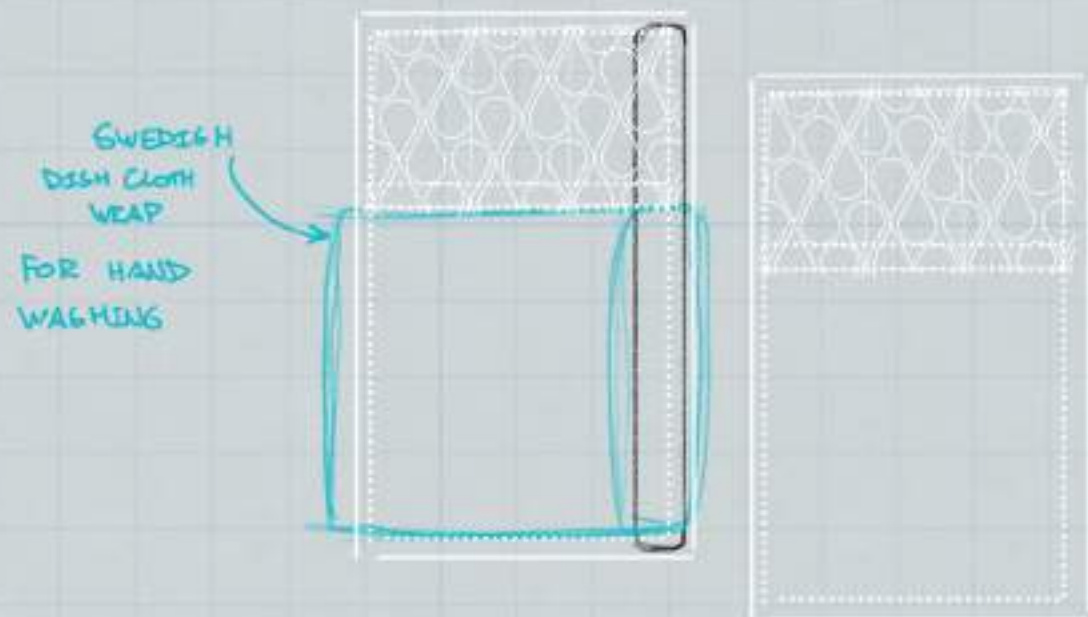
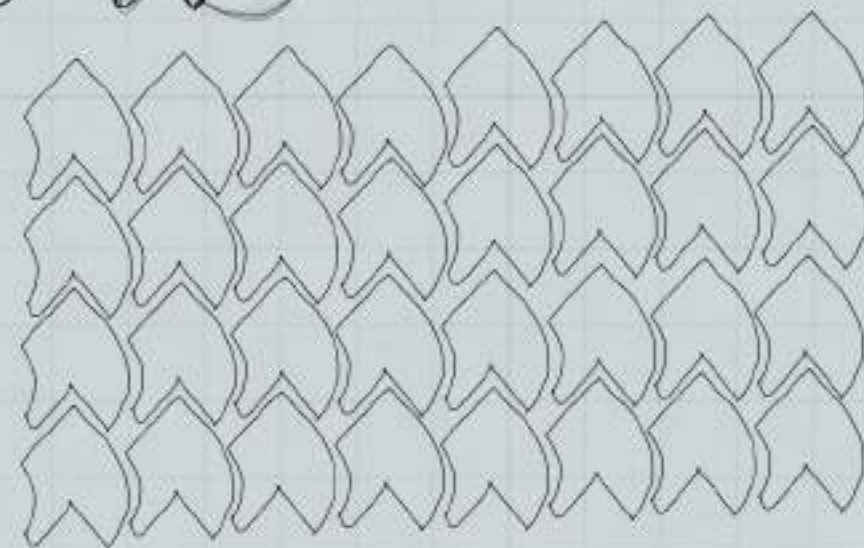
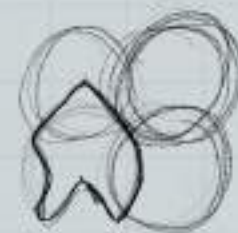
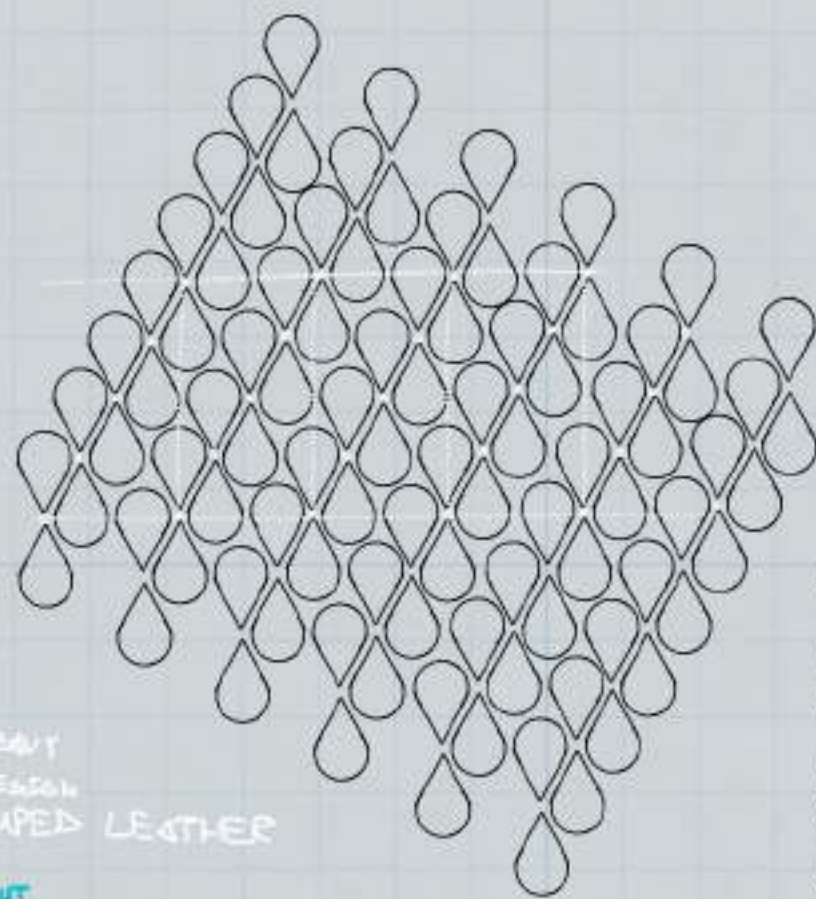
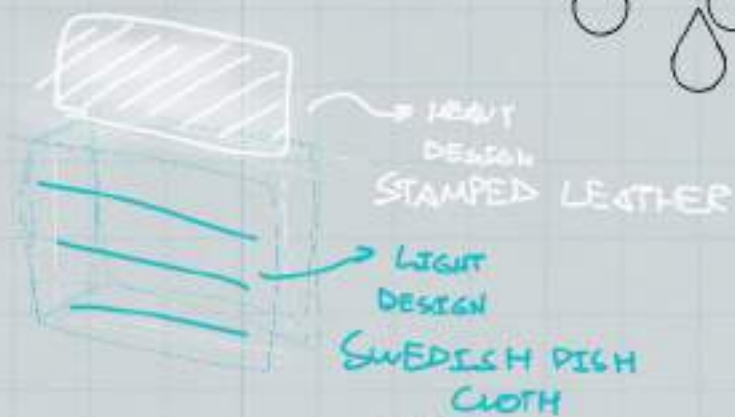
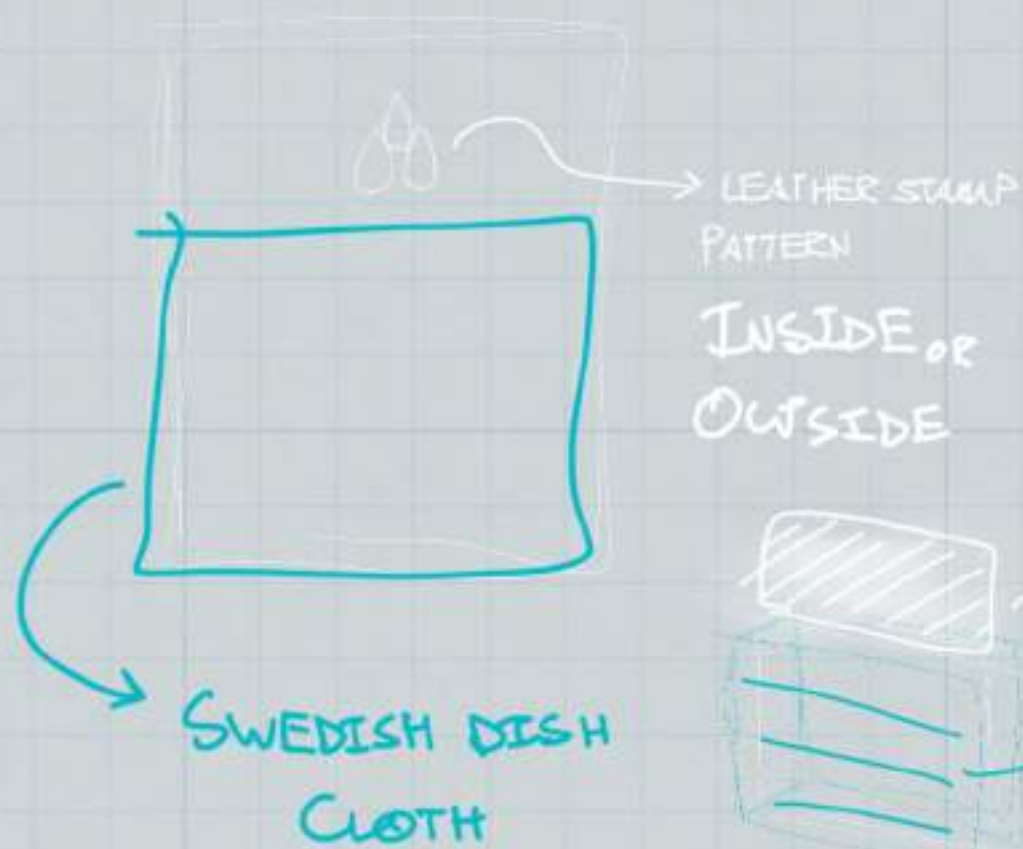

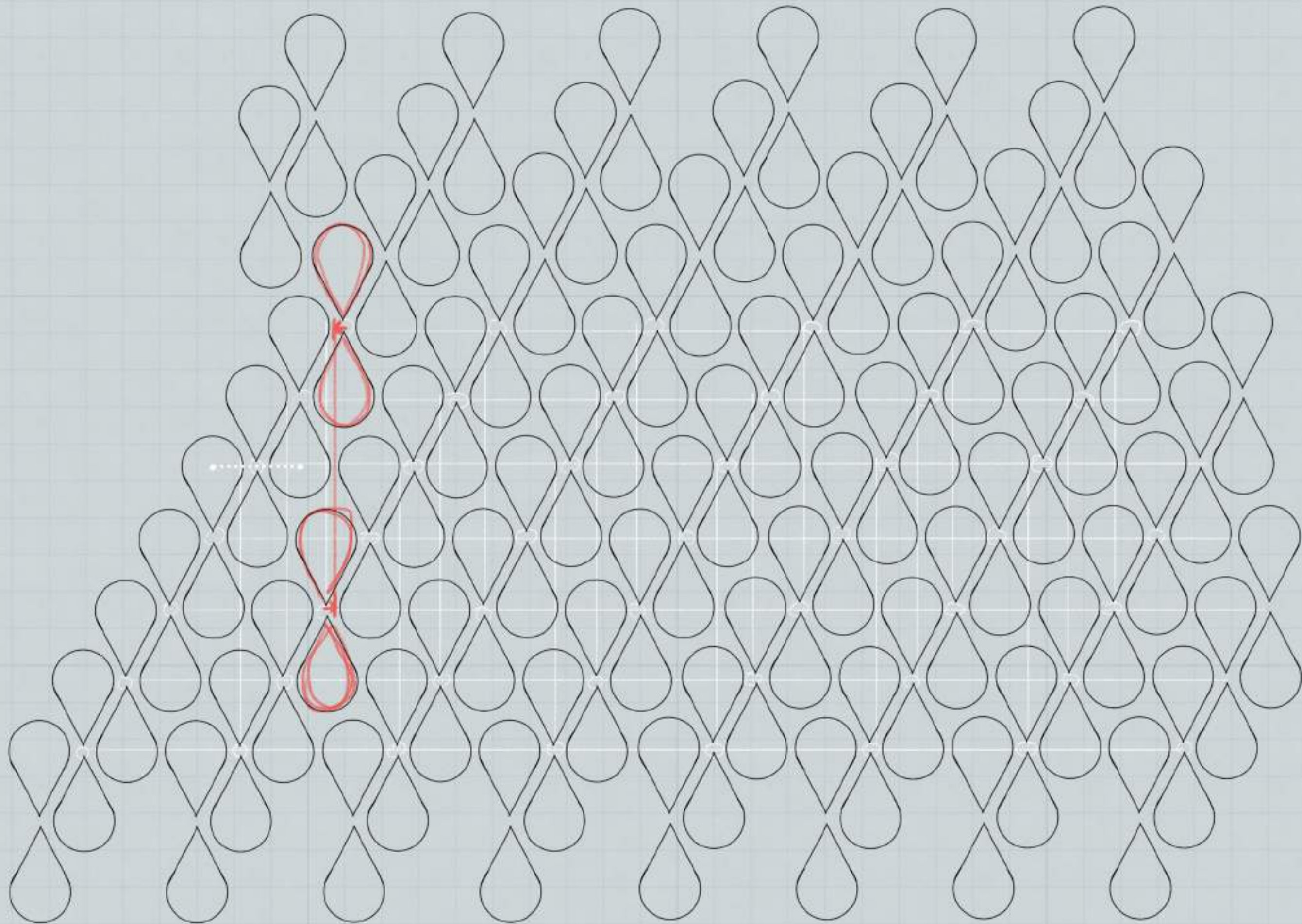

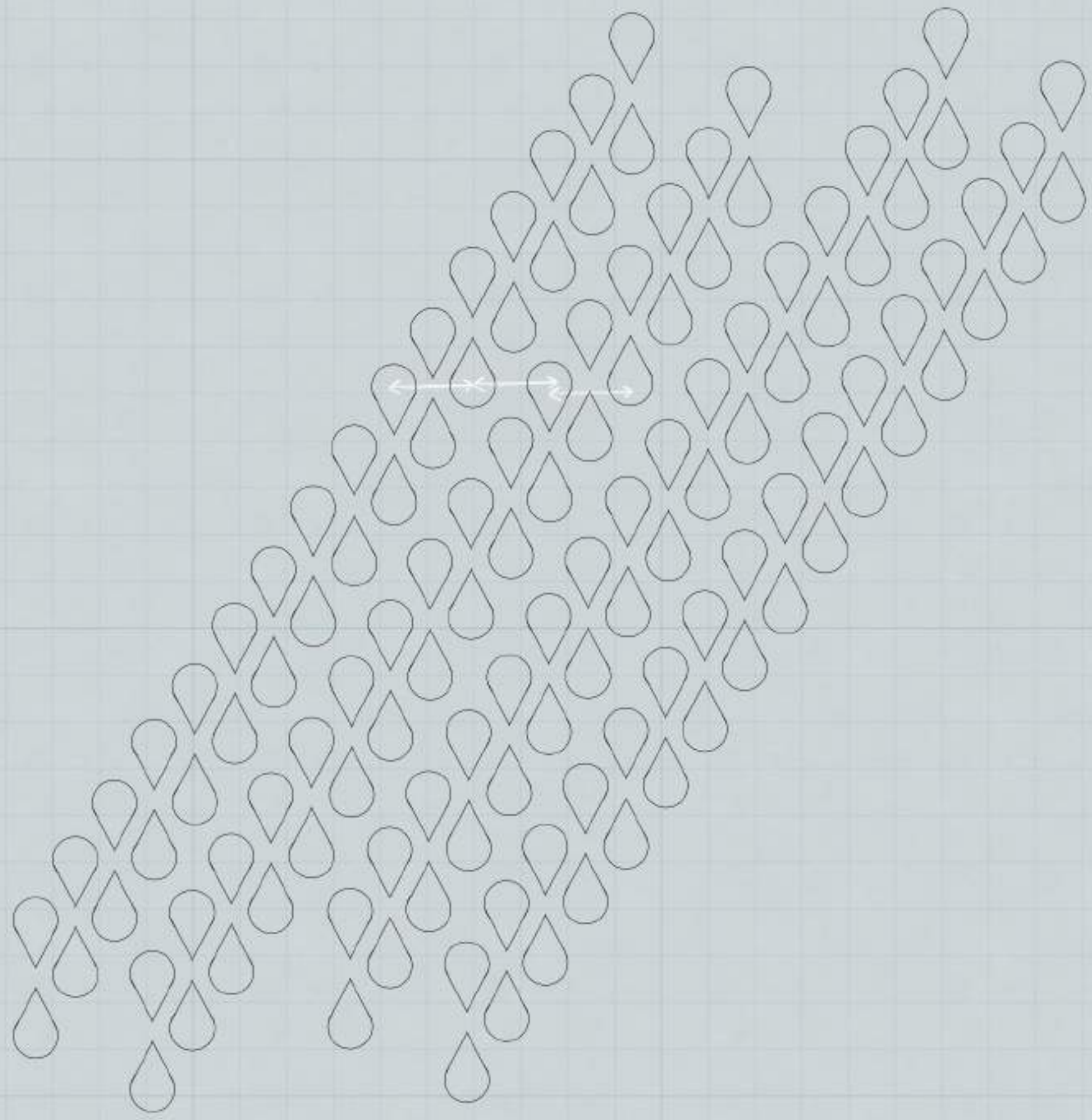

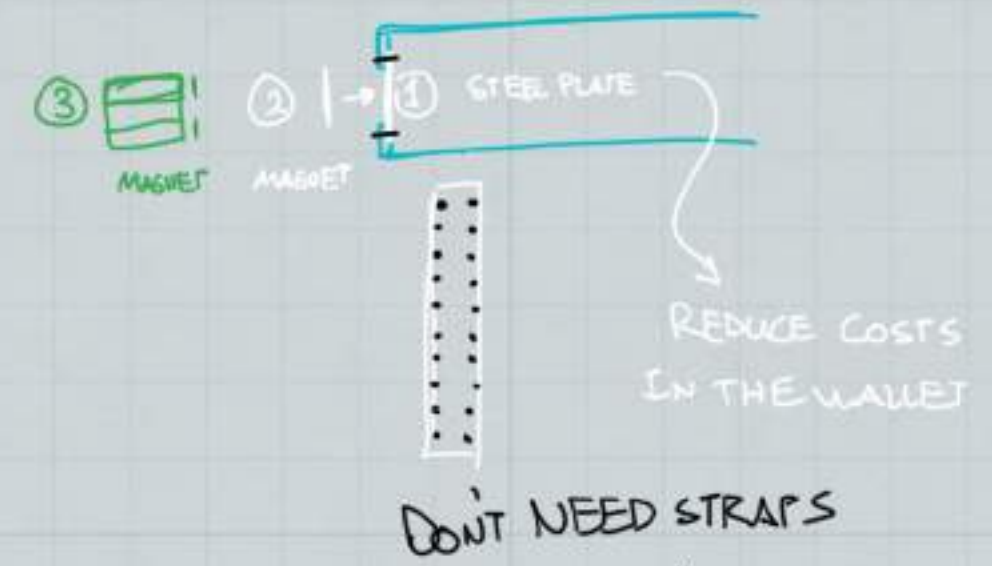
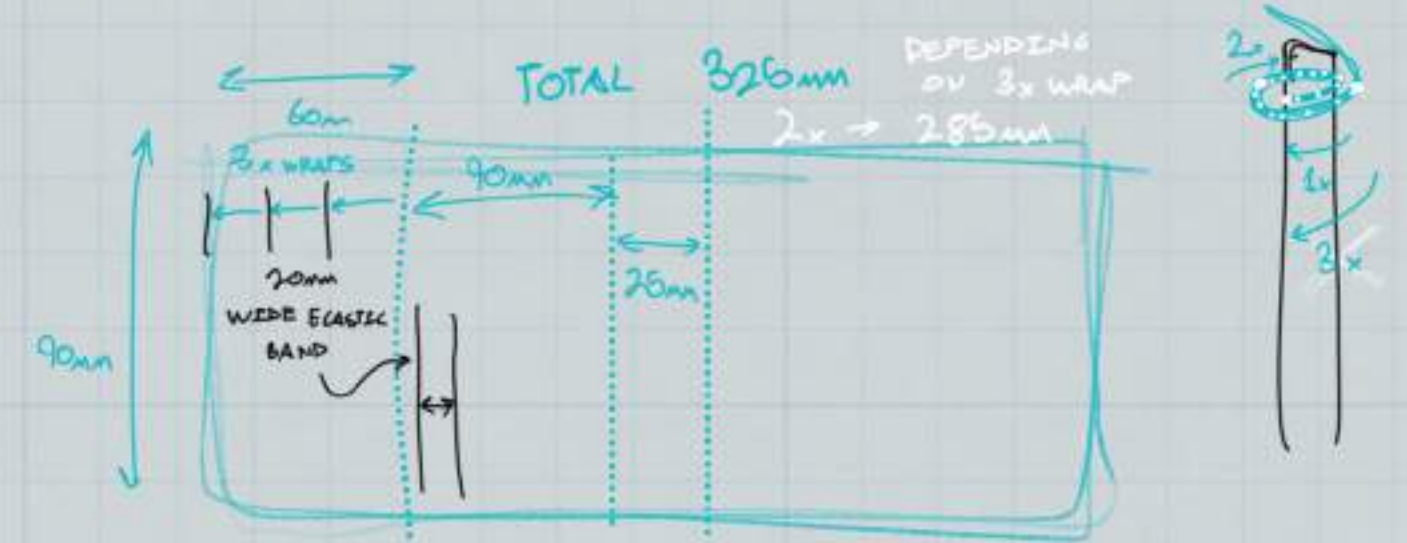
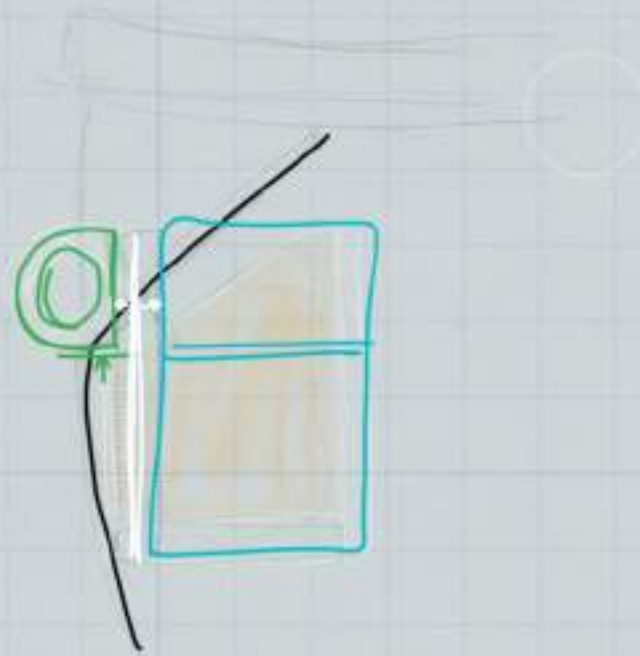

PURSE HOOK CAN
MAGNET DIRECTLY
ONTO

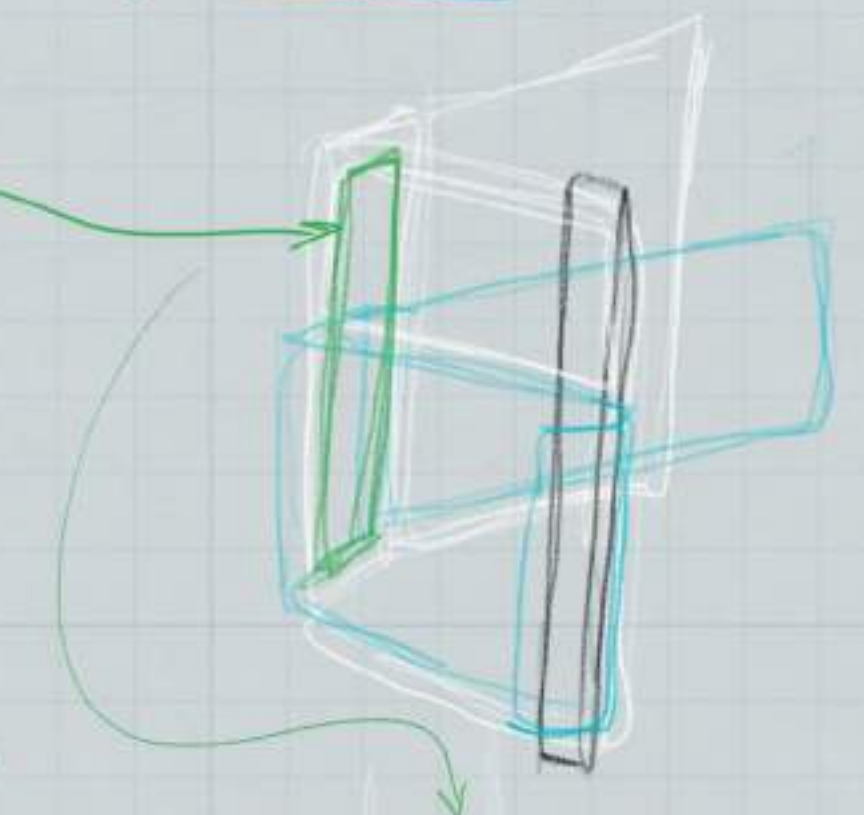

STICK THE WALLET
TO A SURFACE

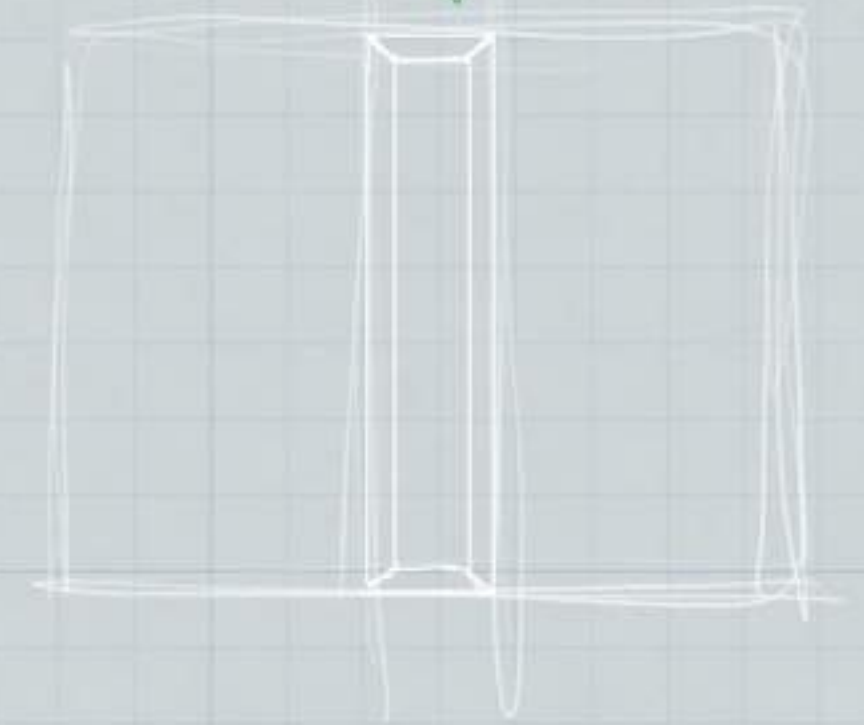
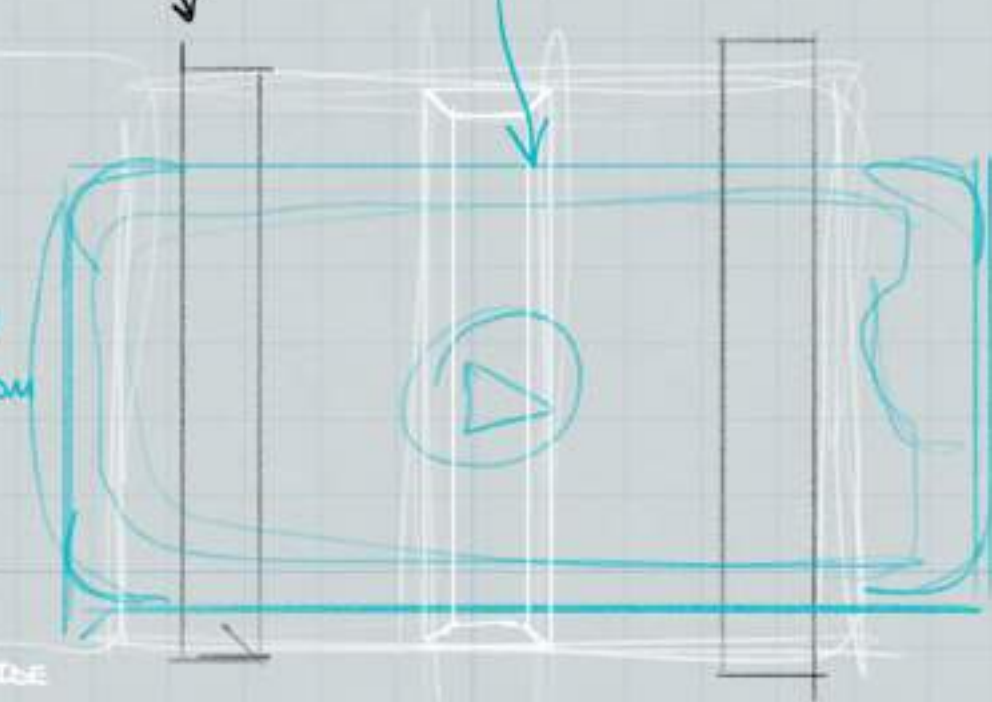
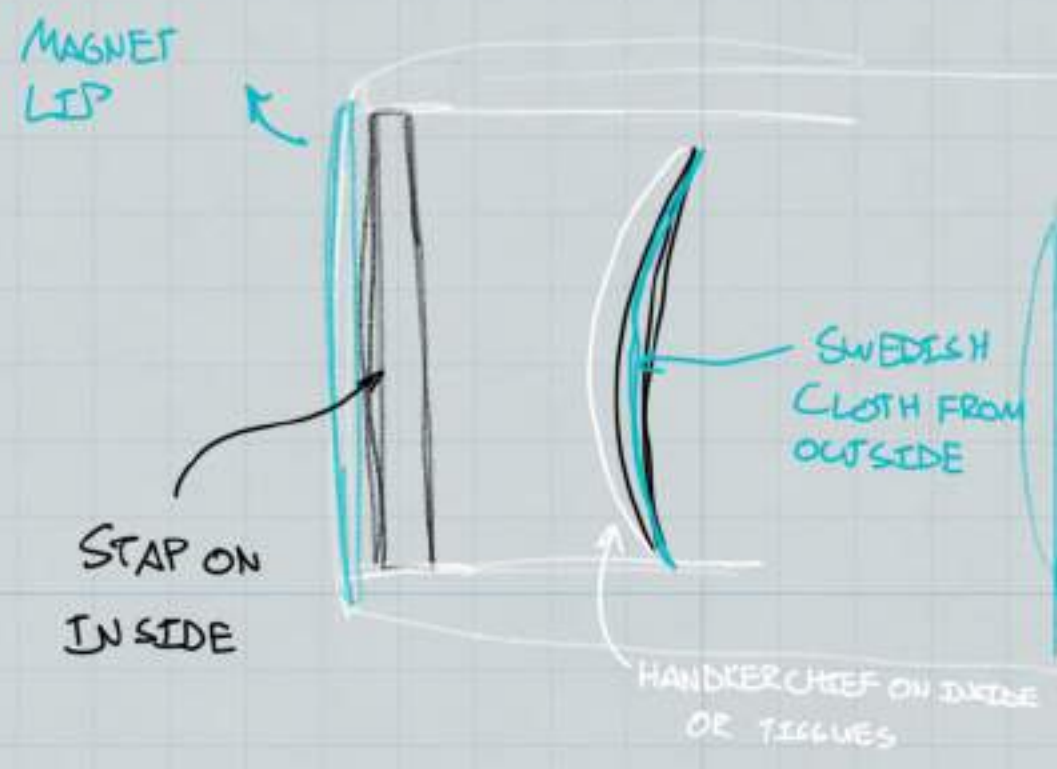

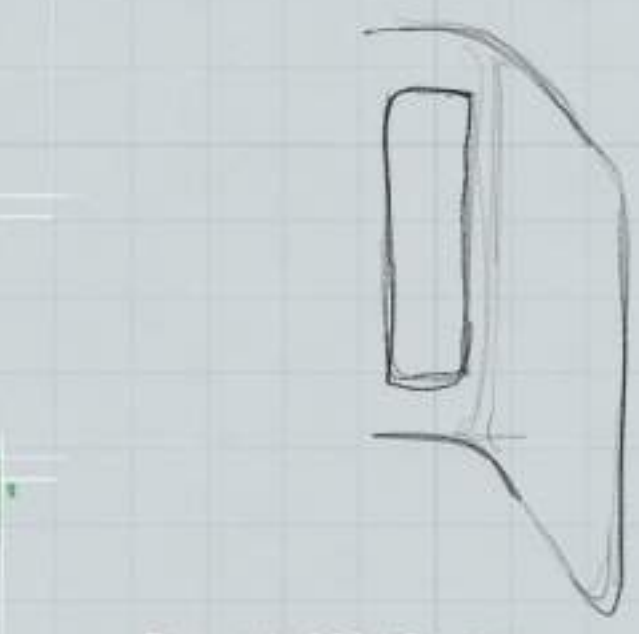
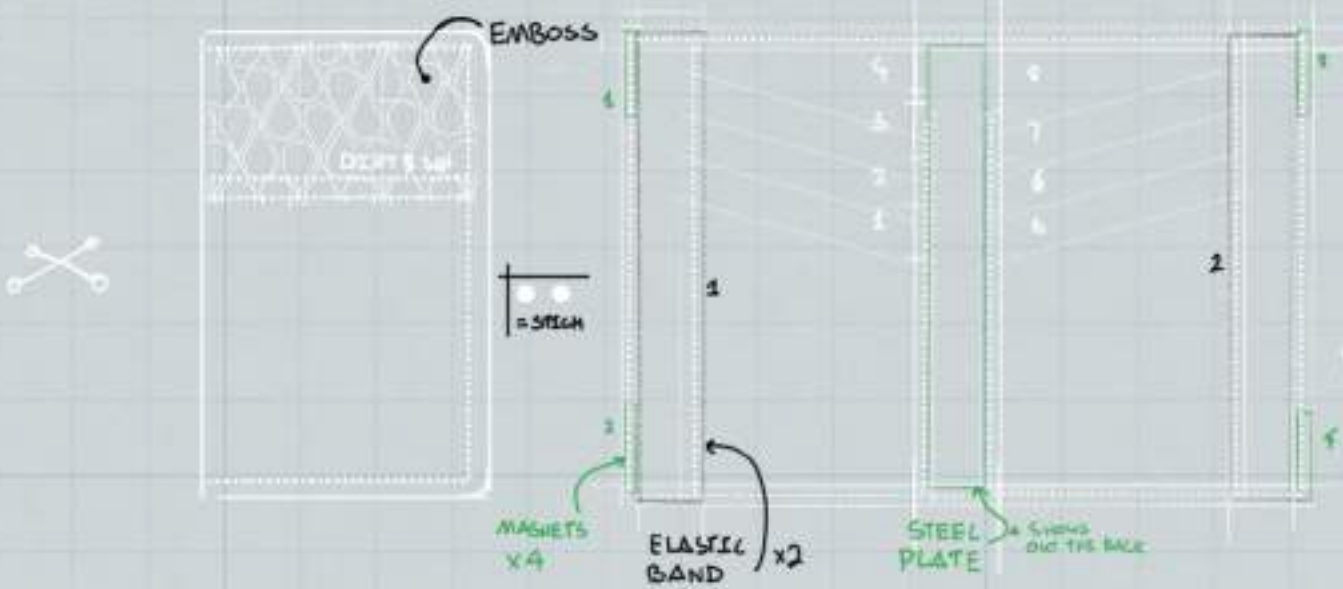
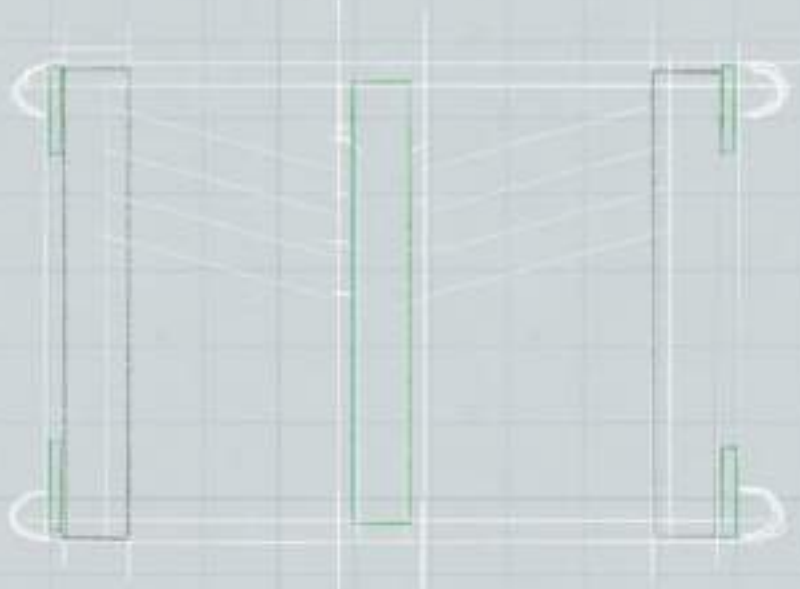
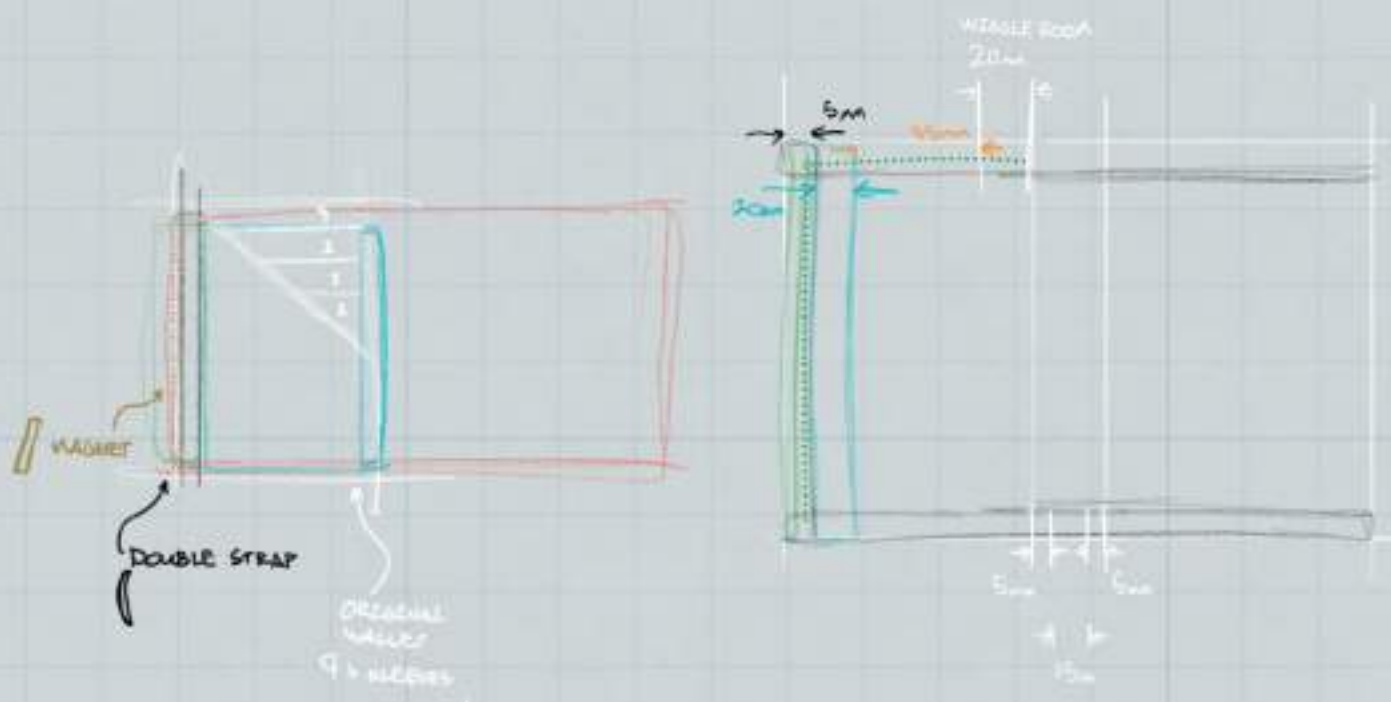

PUT ON OTHER SIDE

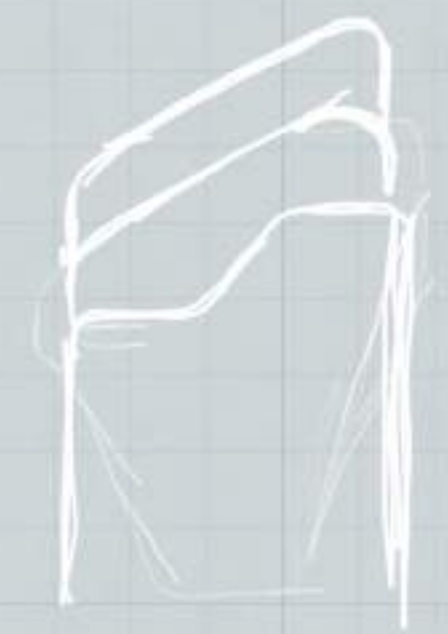
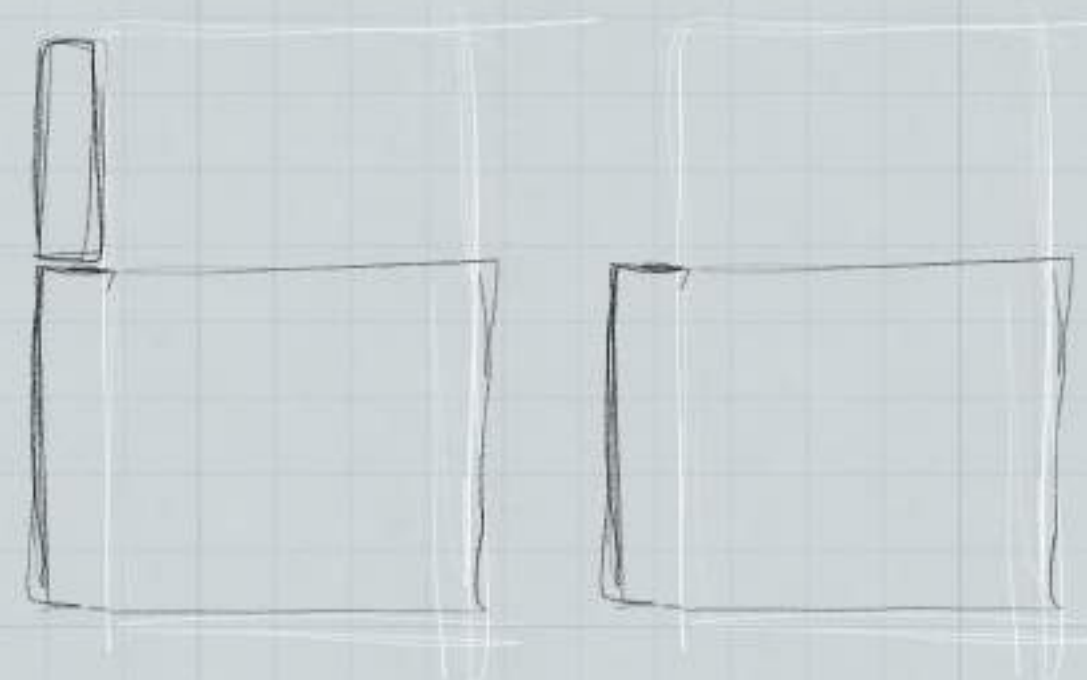
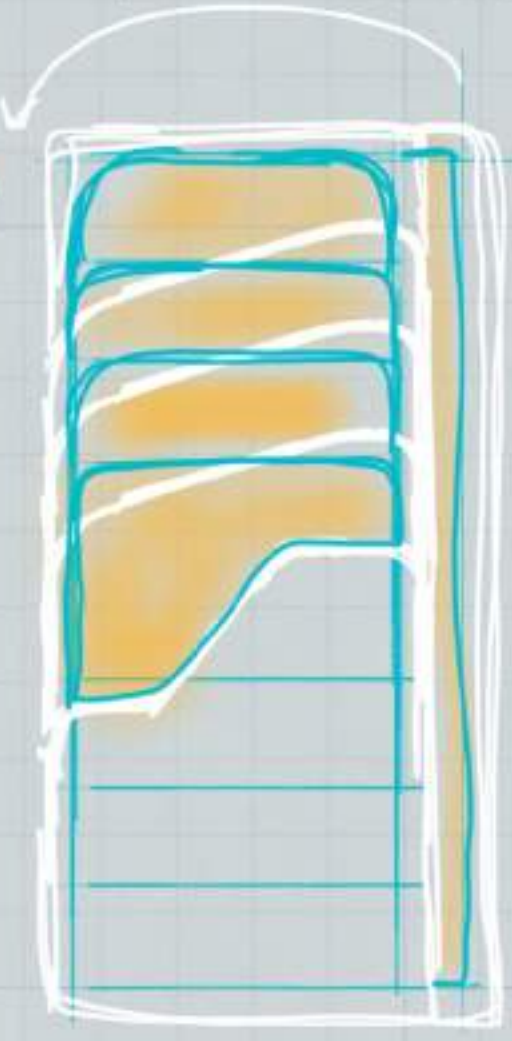

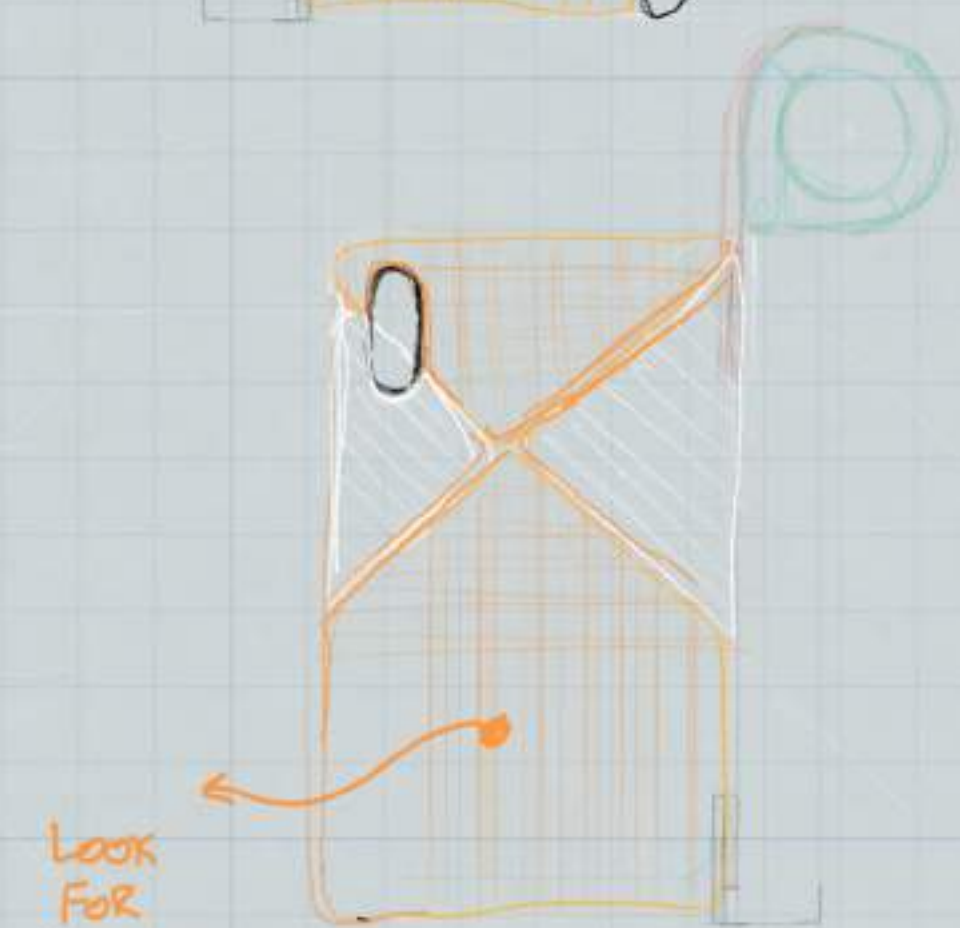
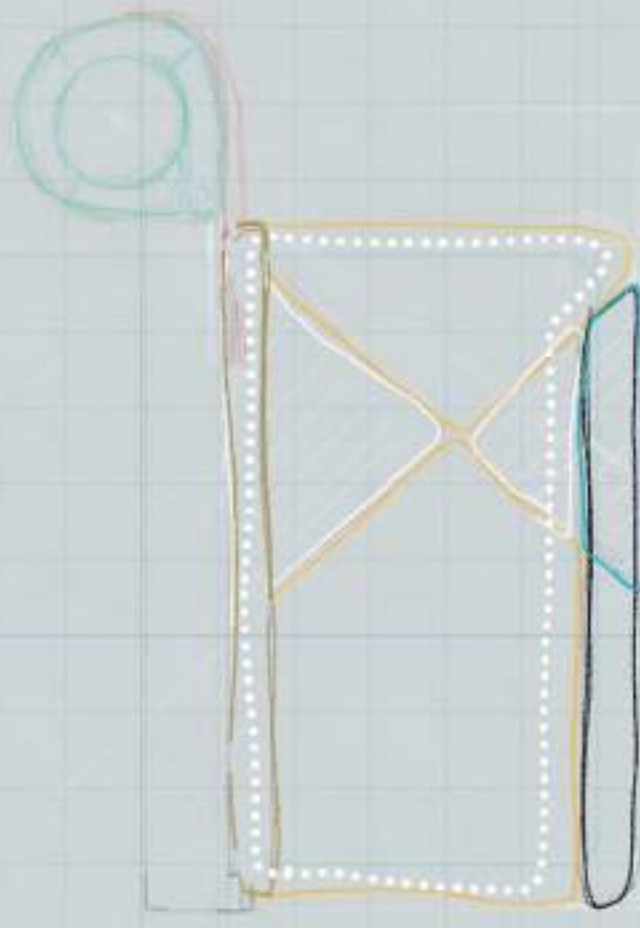
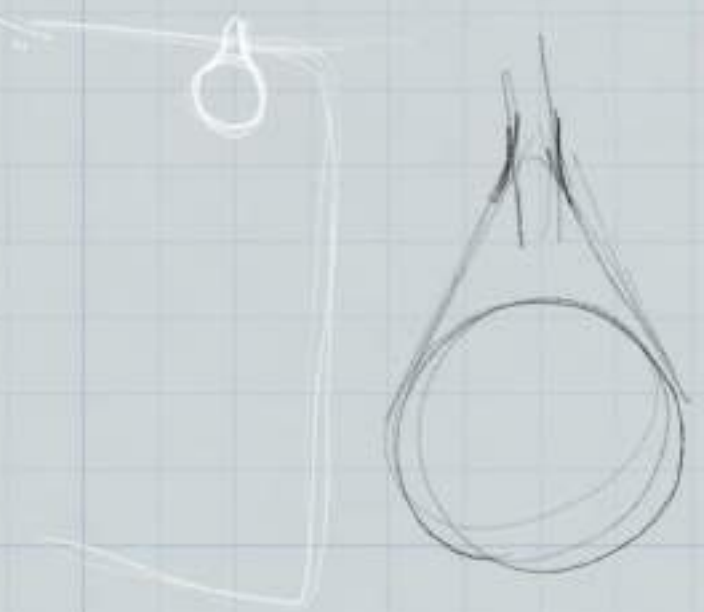
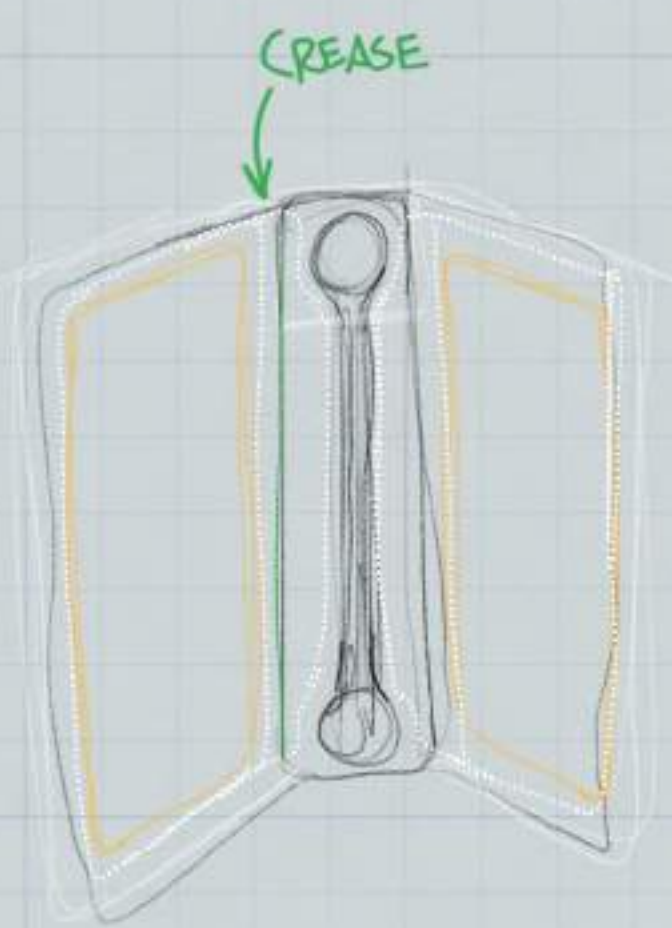
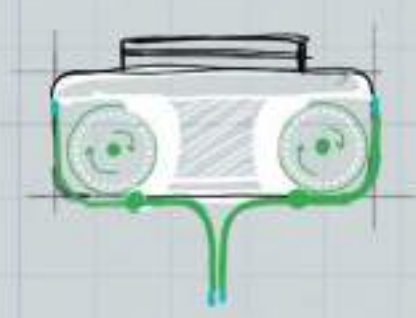
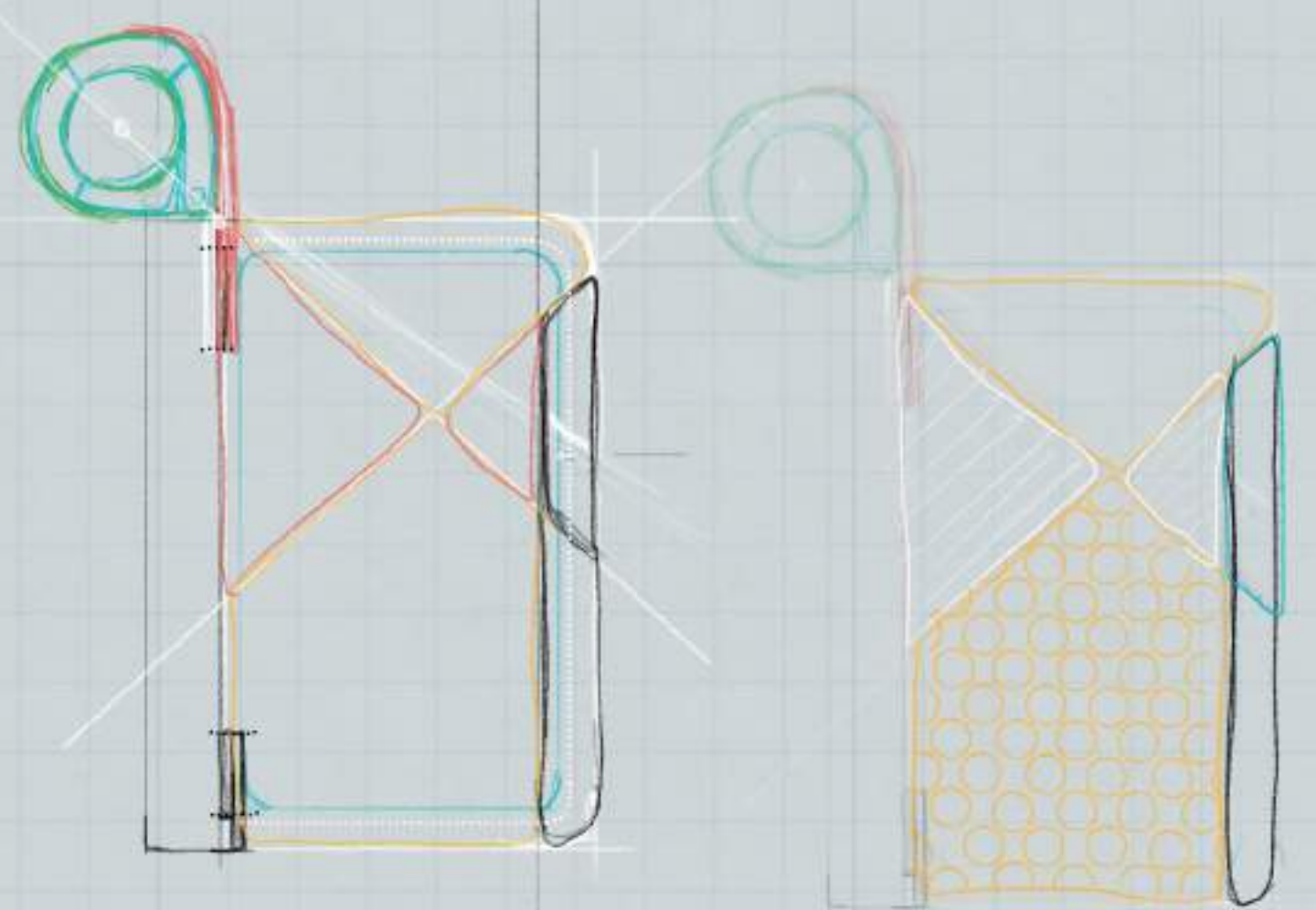

LOOK FOR
A COOL
PATTERN

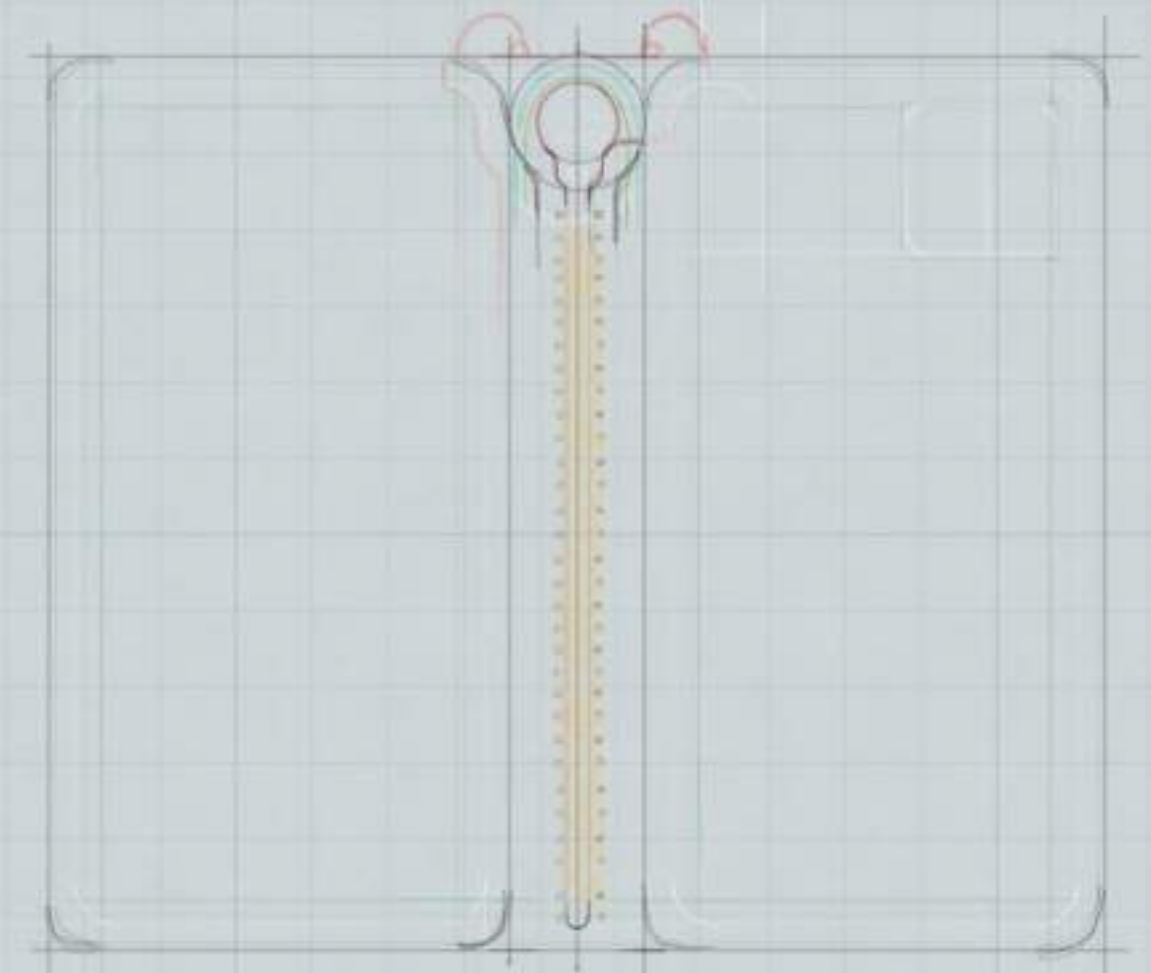
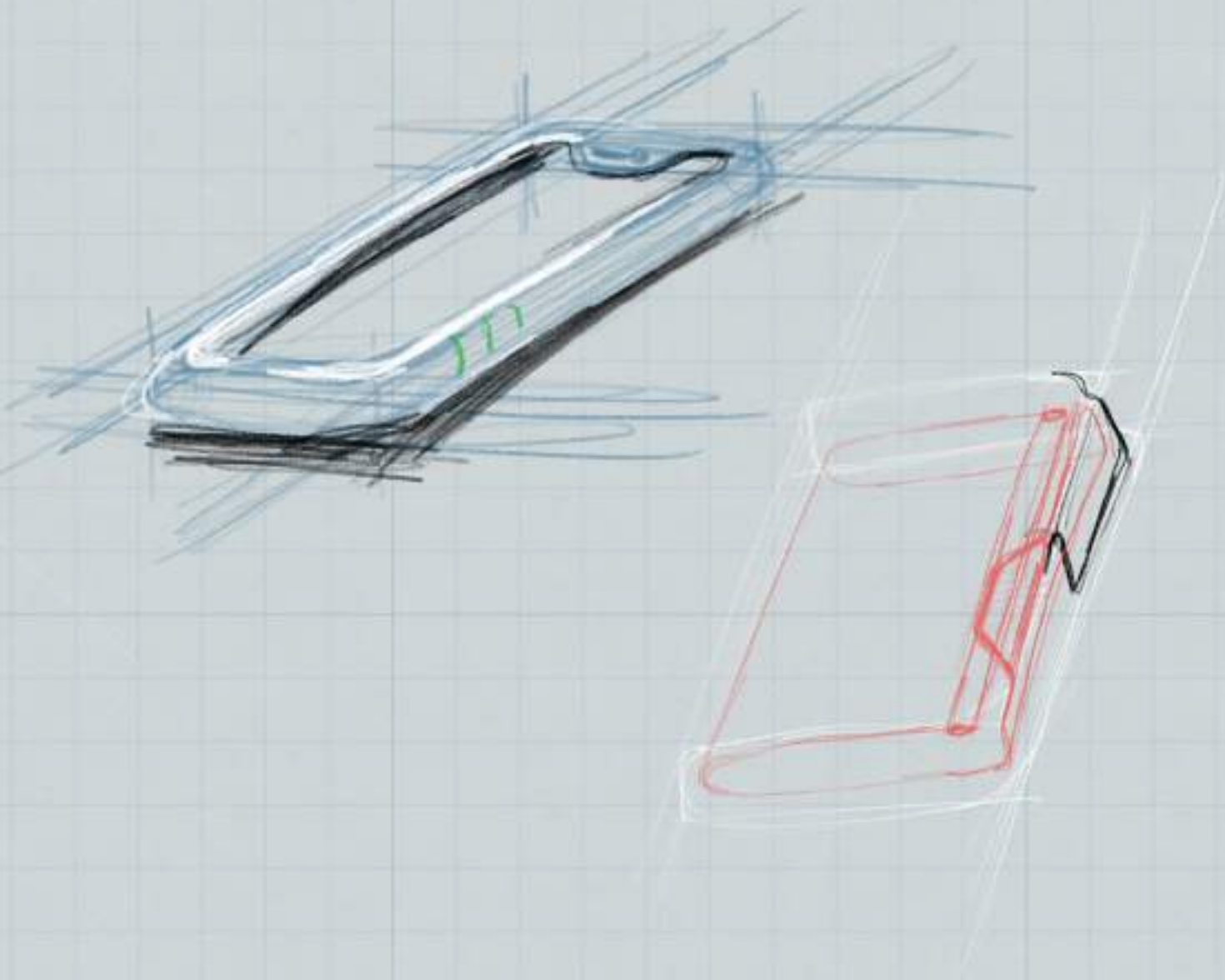
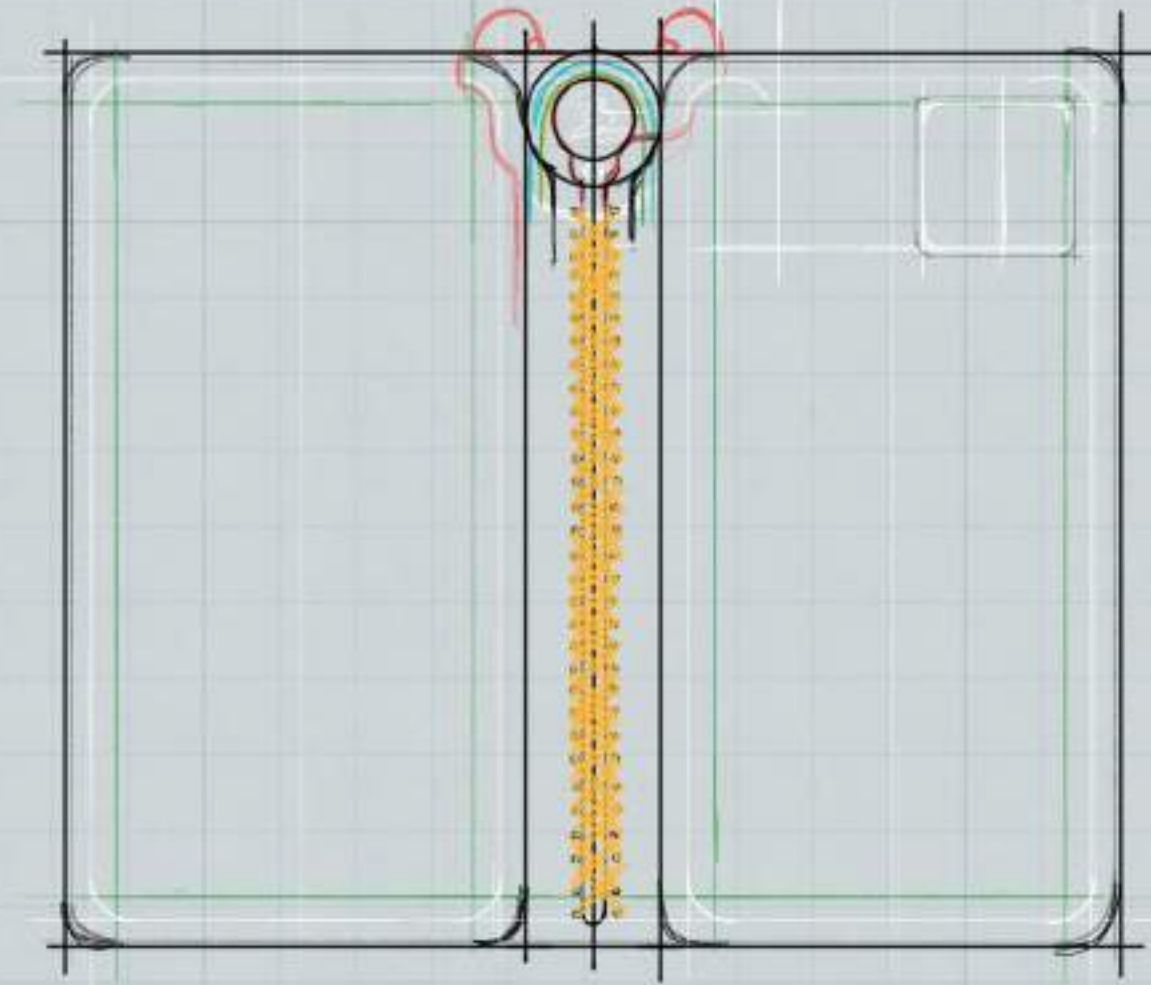
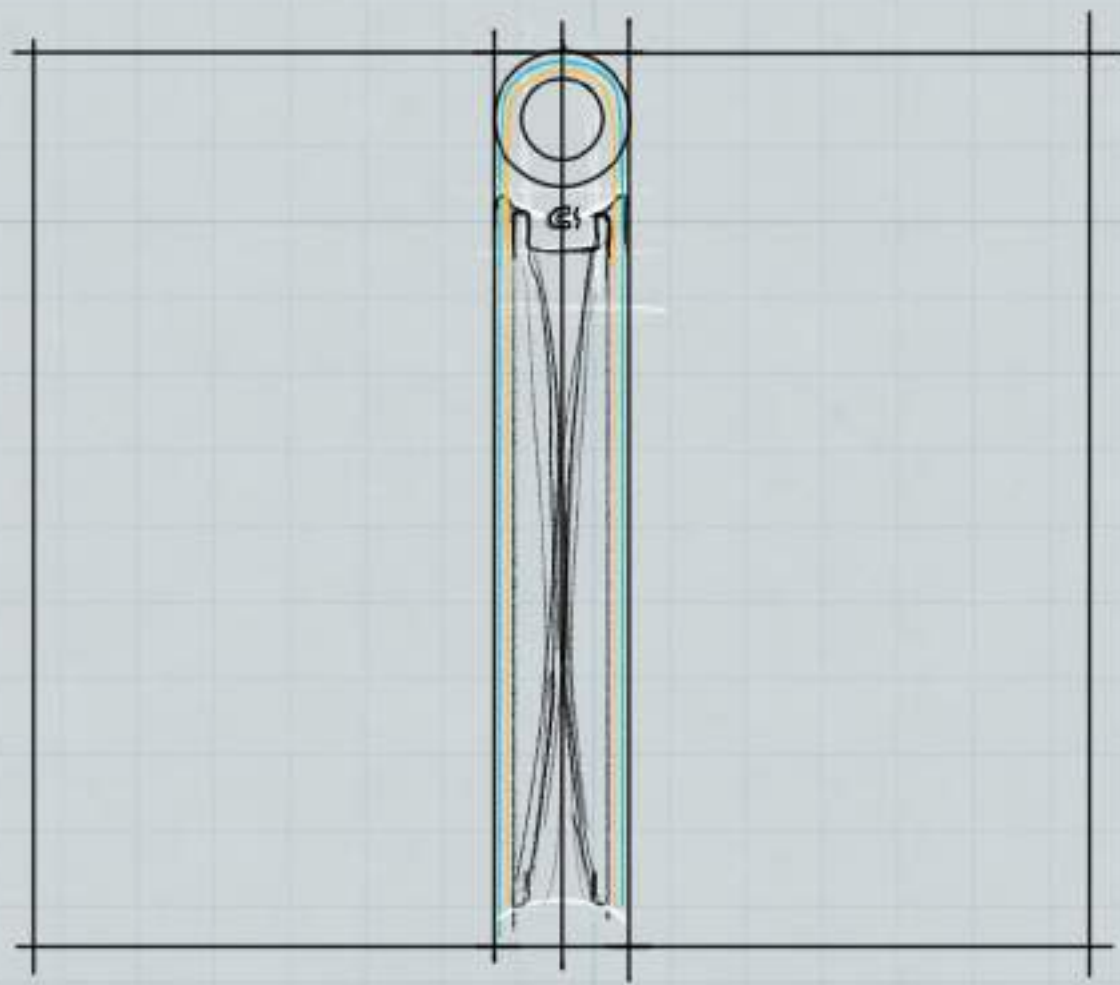

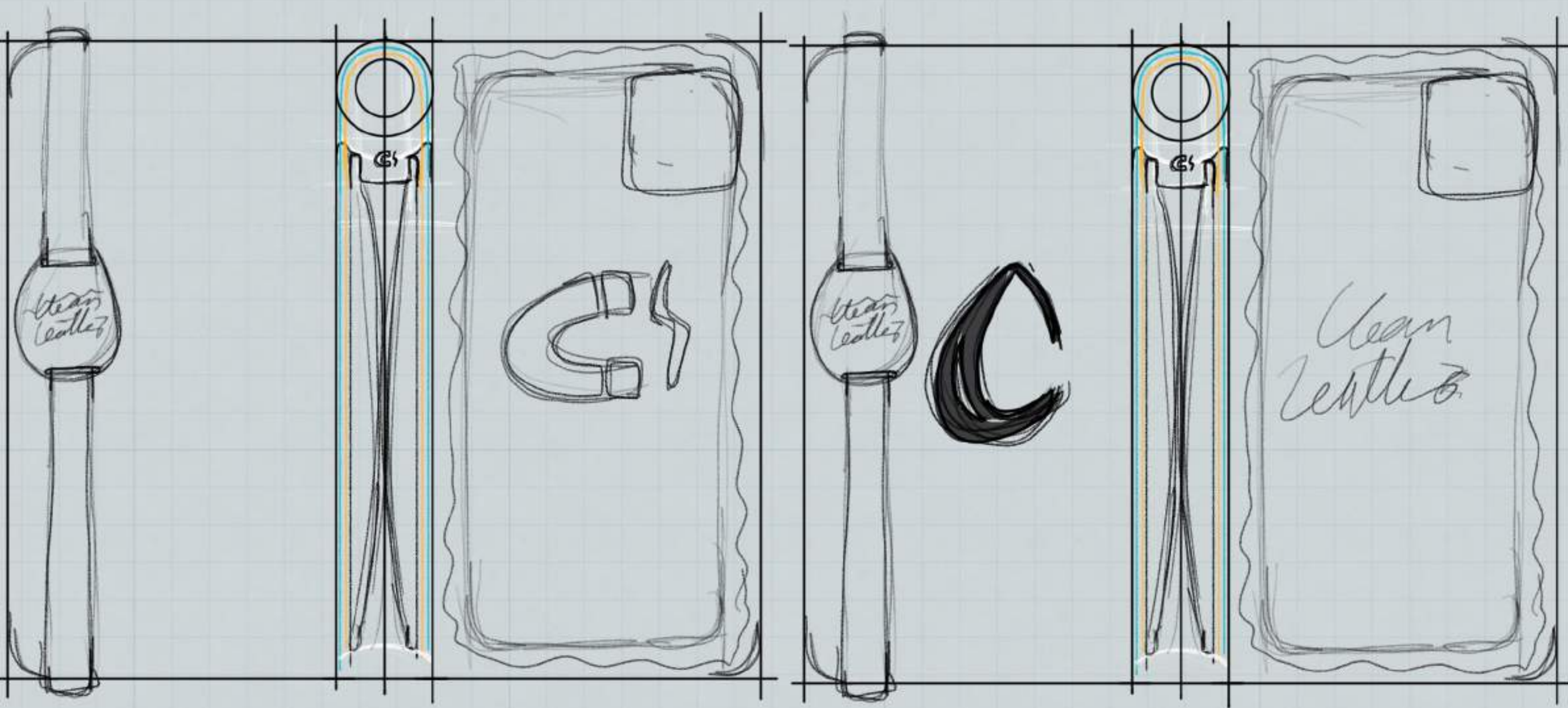

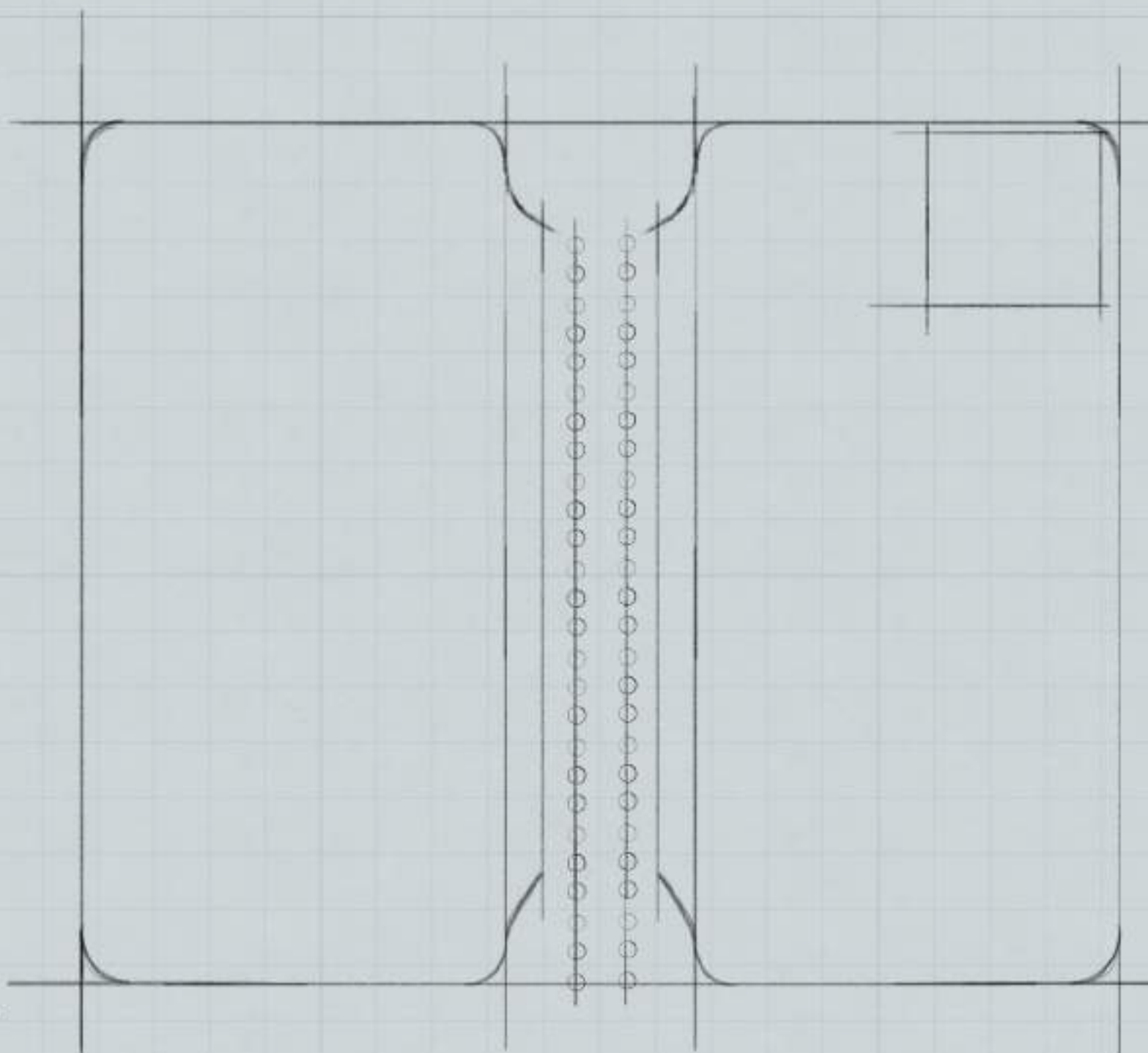
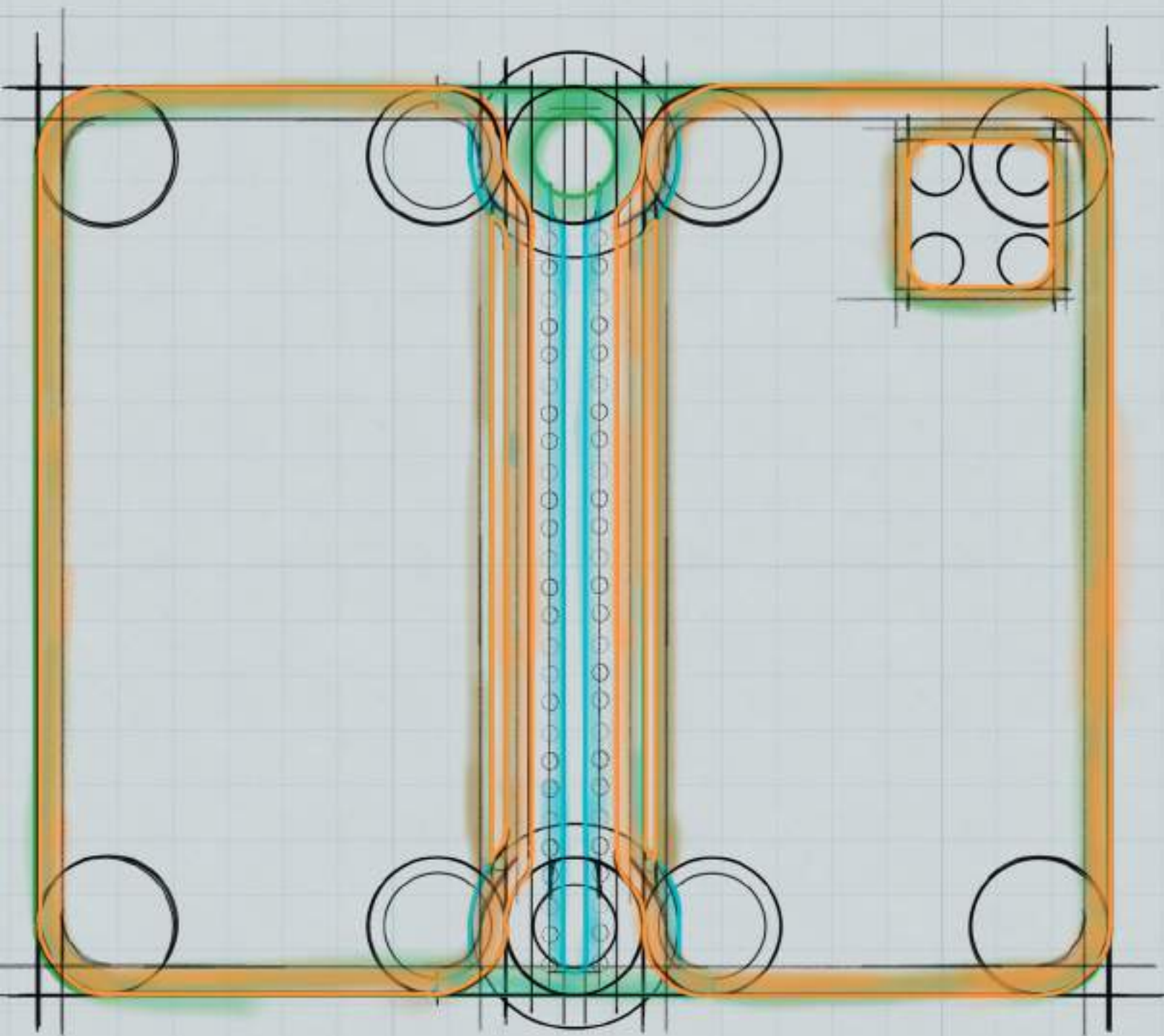

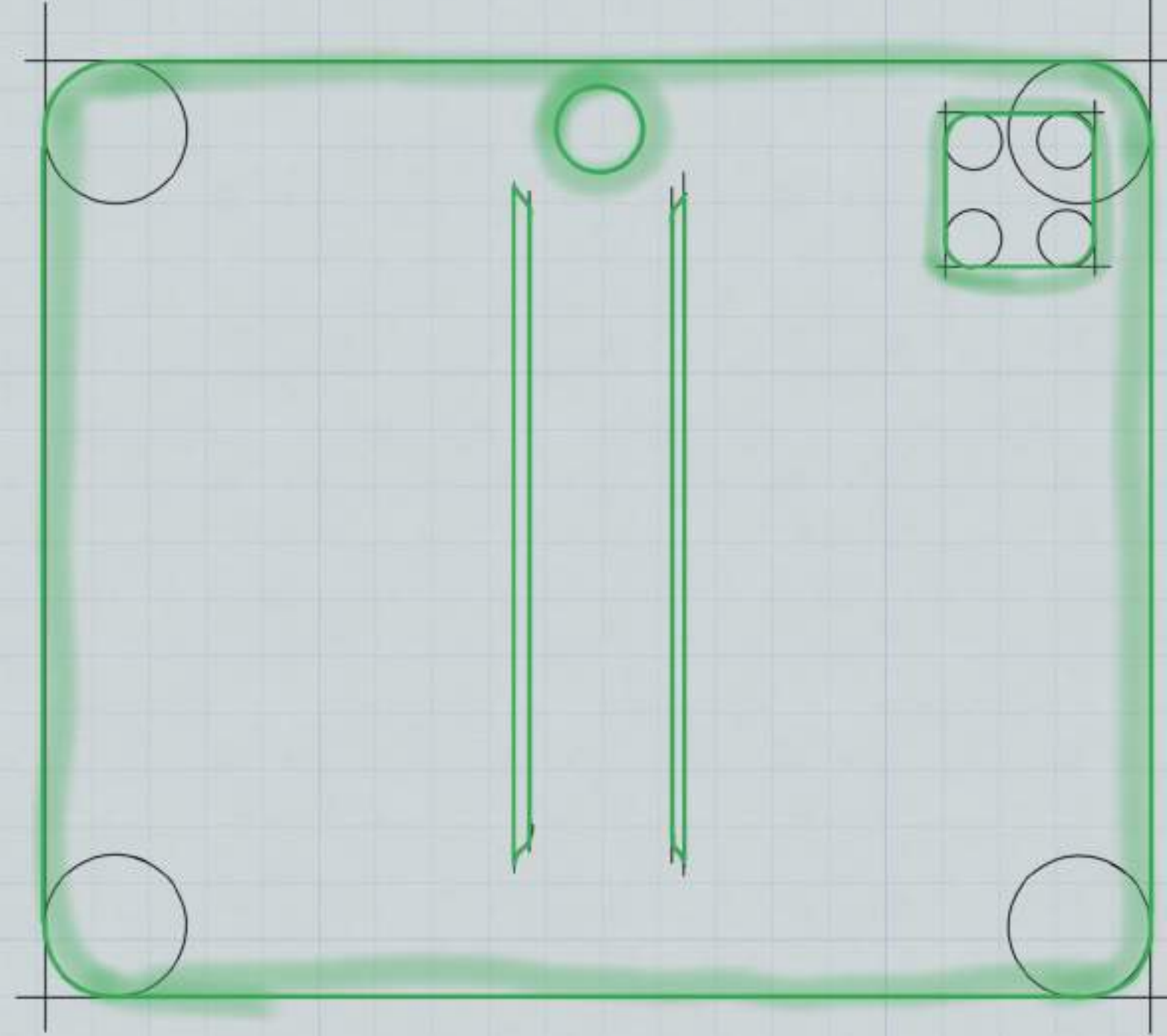
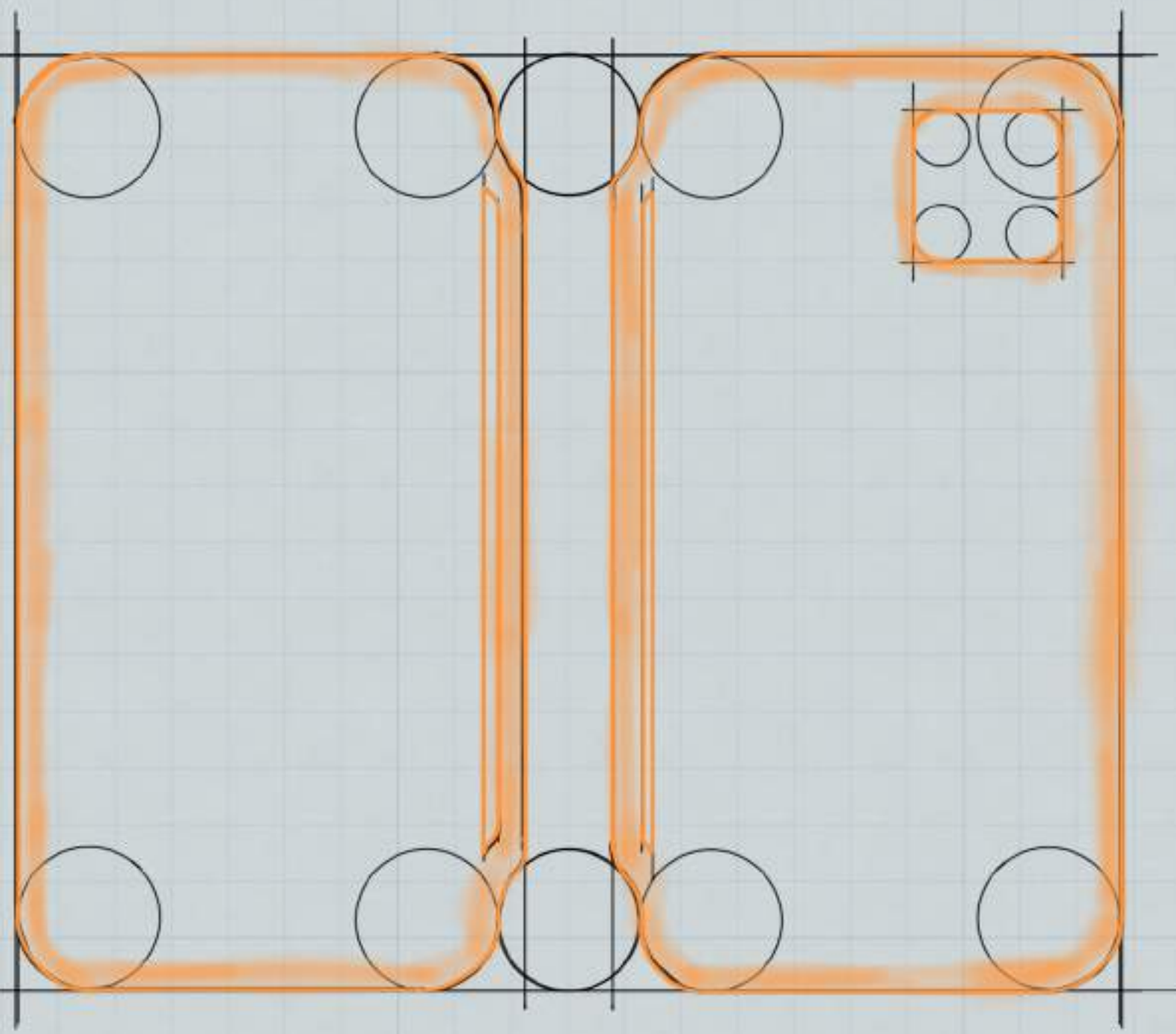

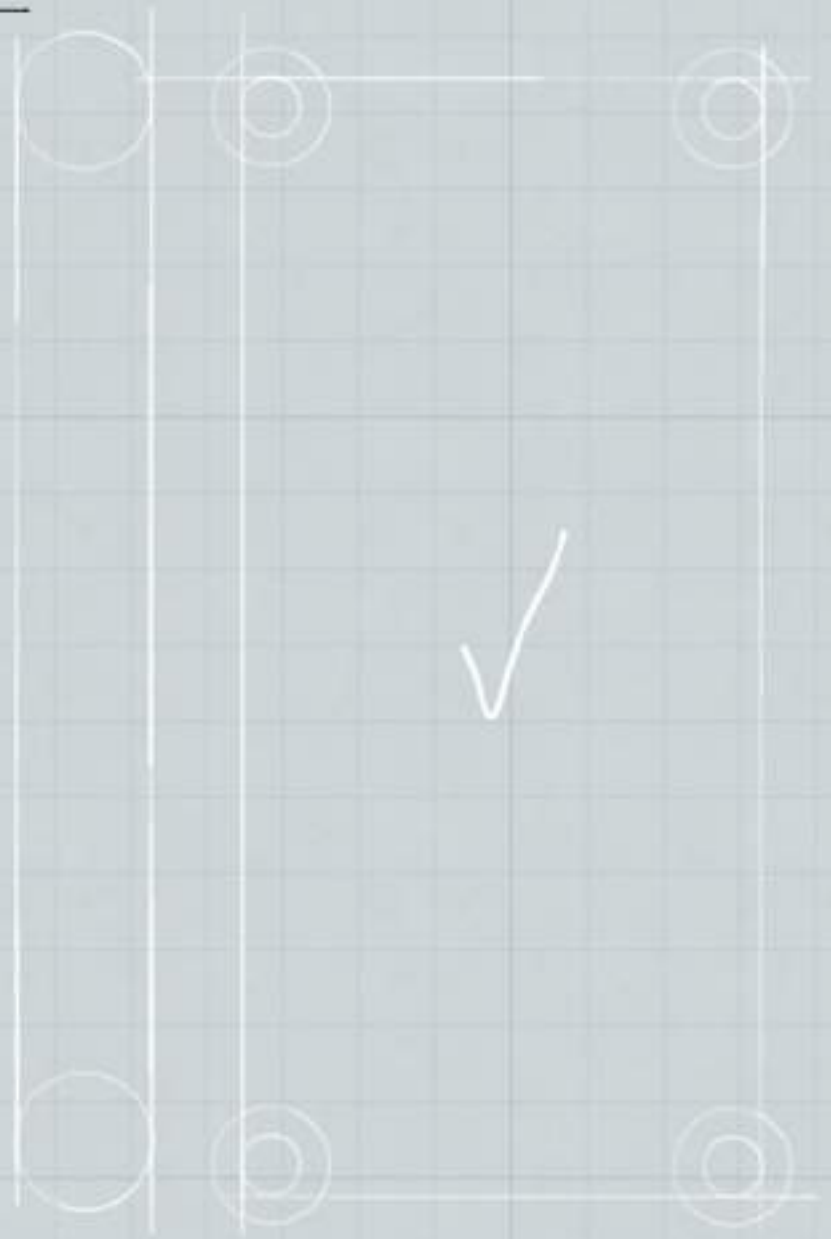
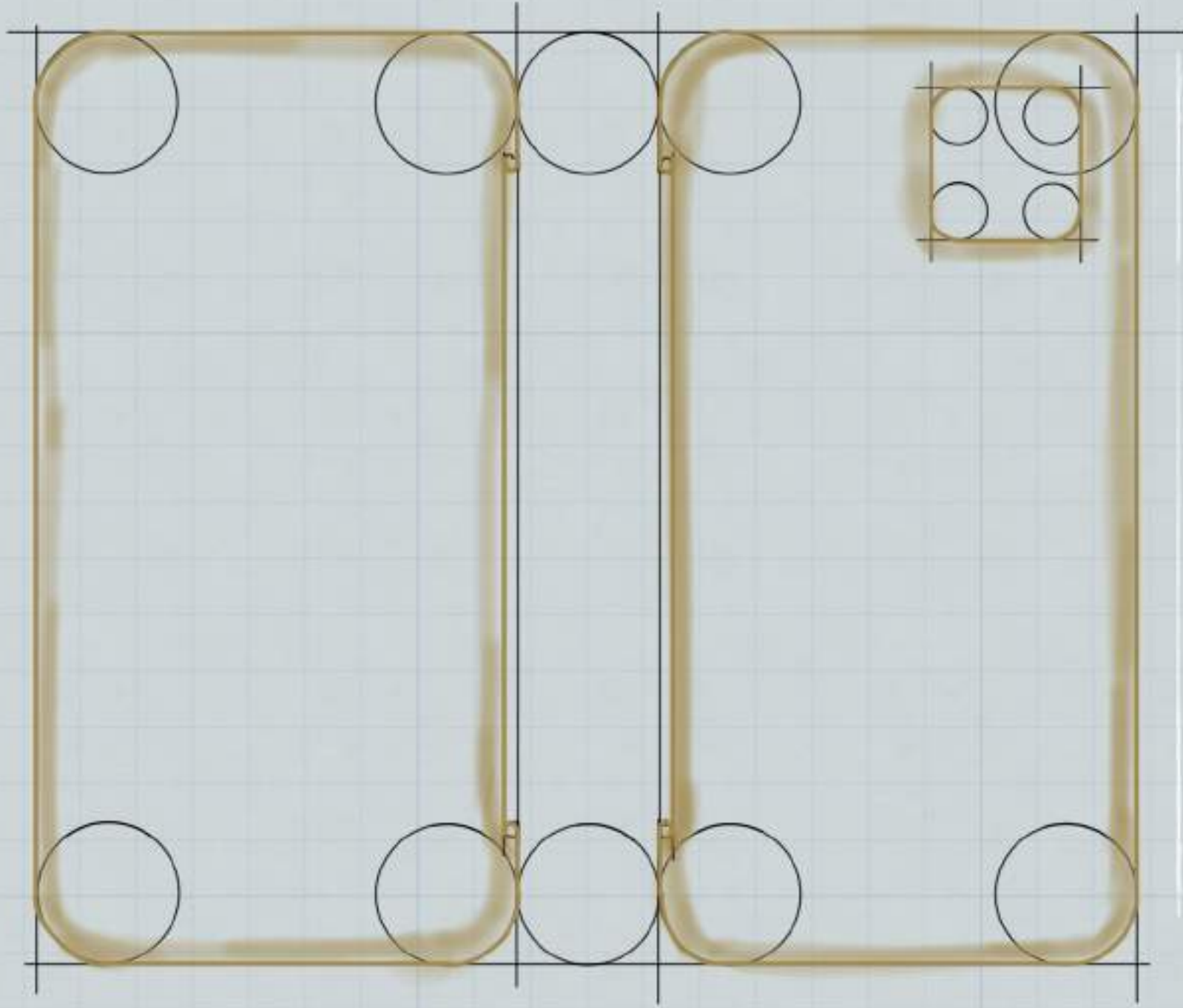
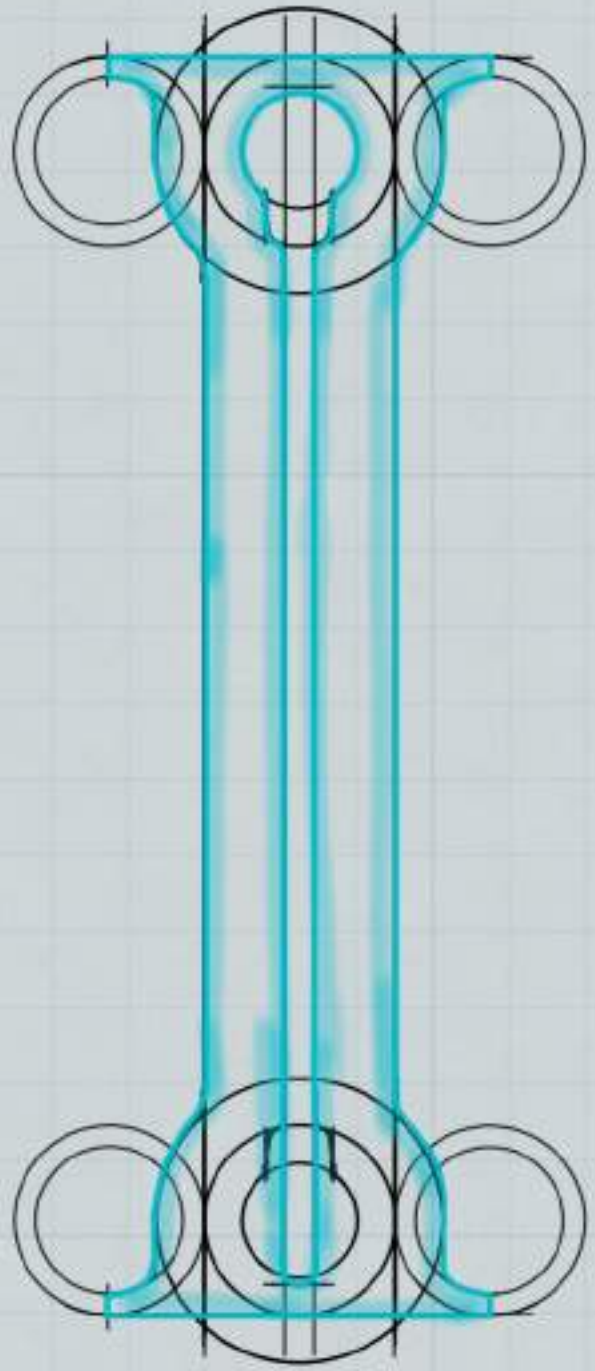



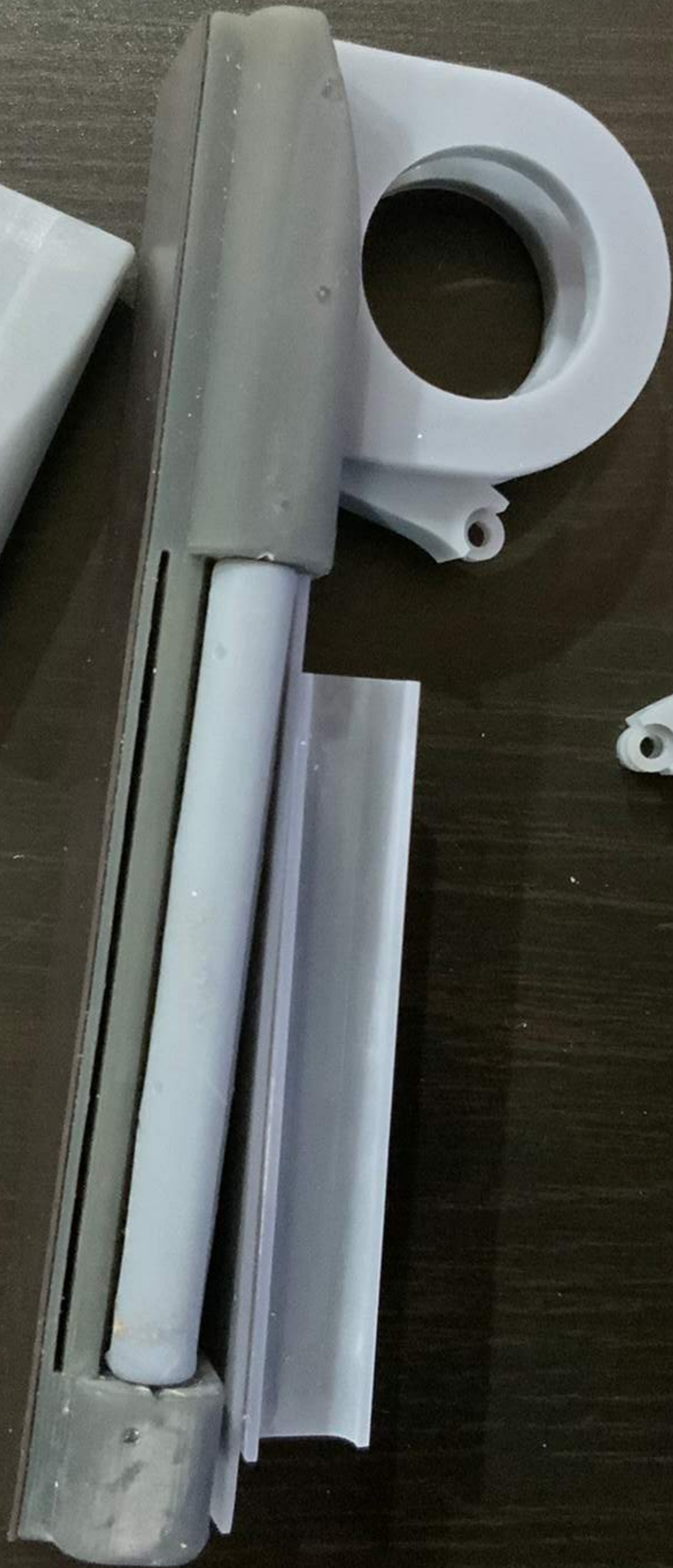







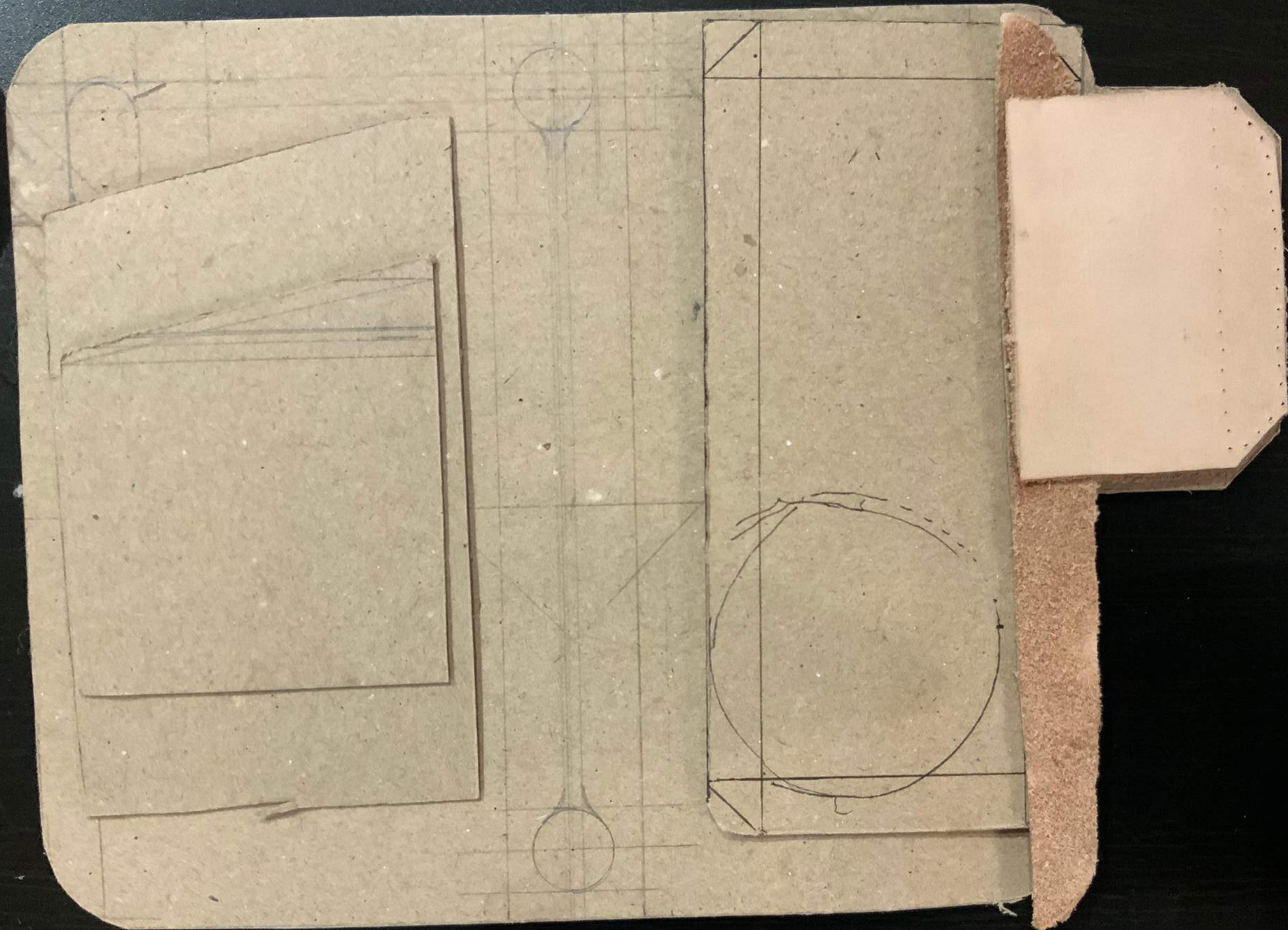



30m

17m

